

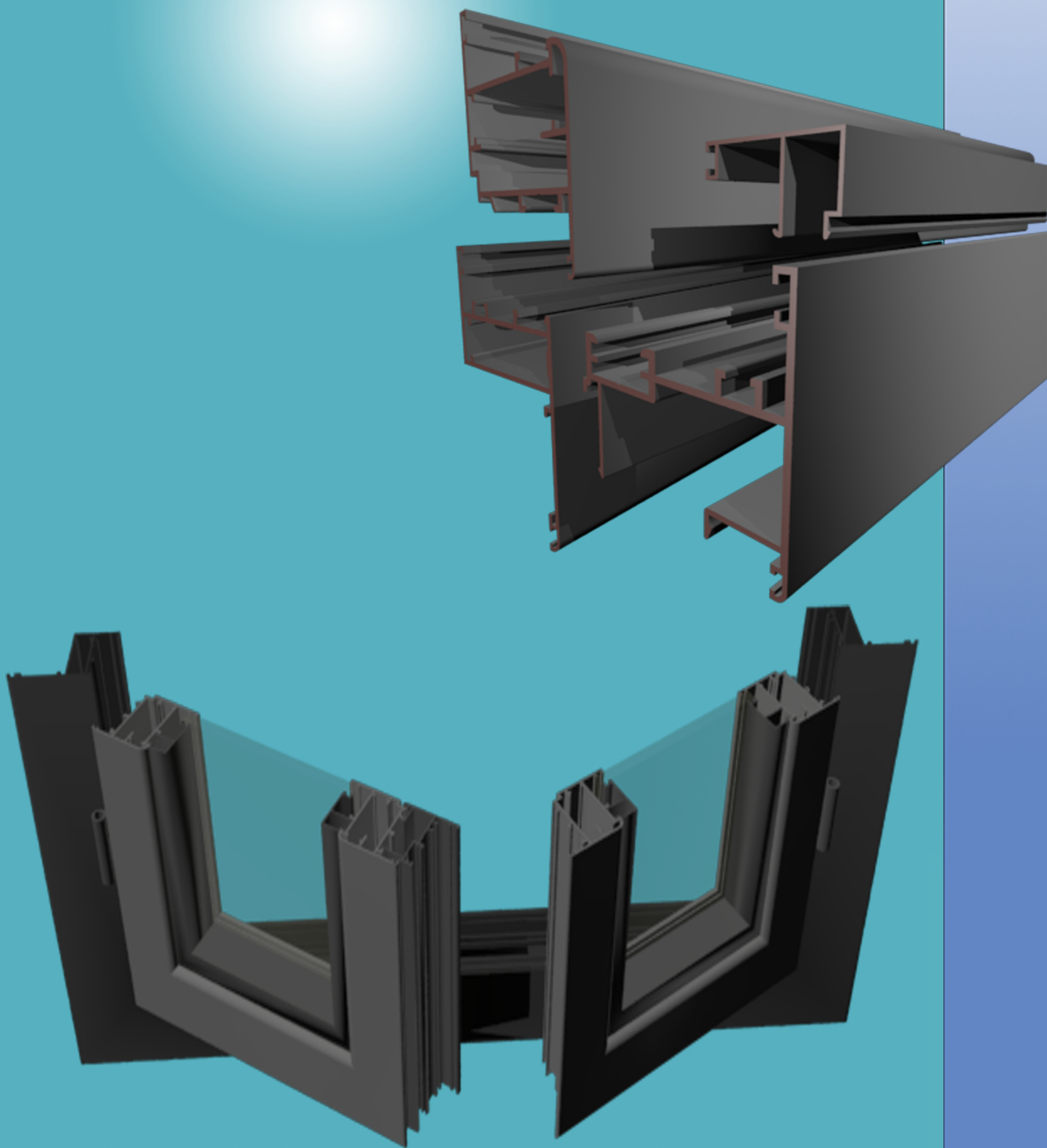

HINGED SYSTEM

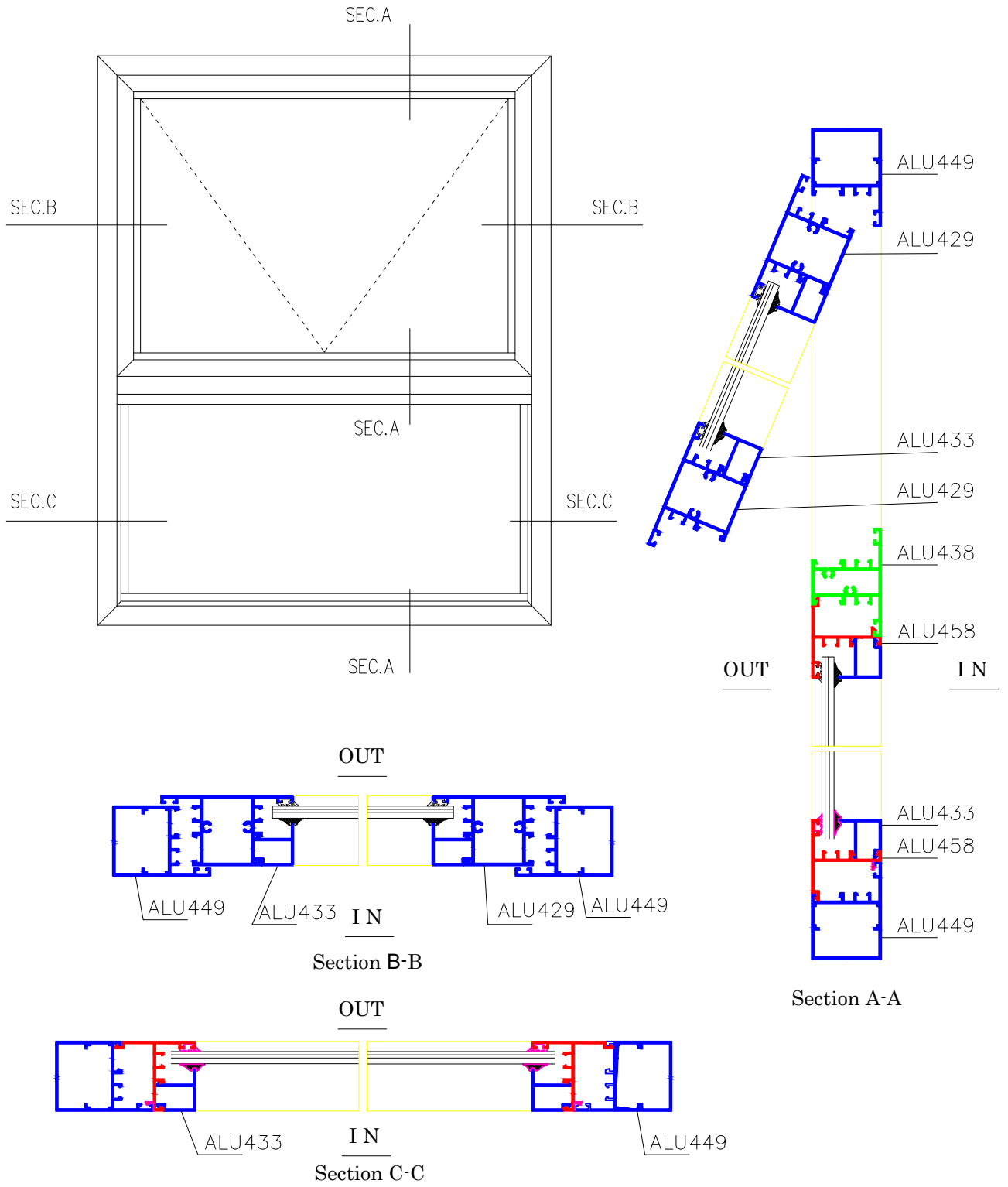

Tilted Window:



Hinged Window:

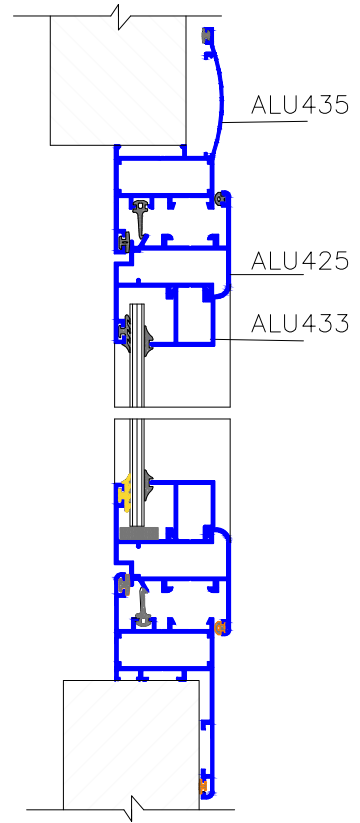
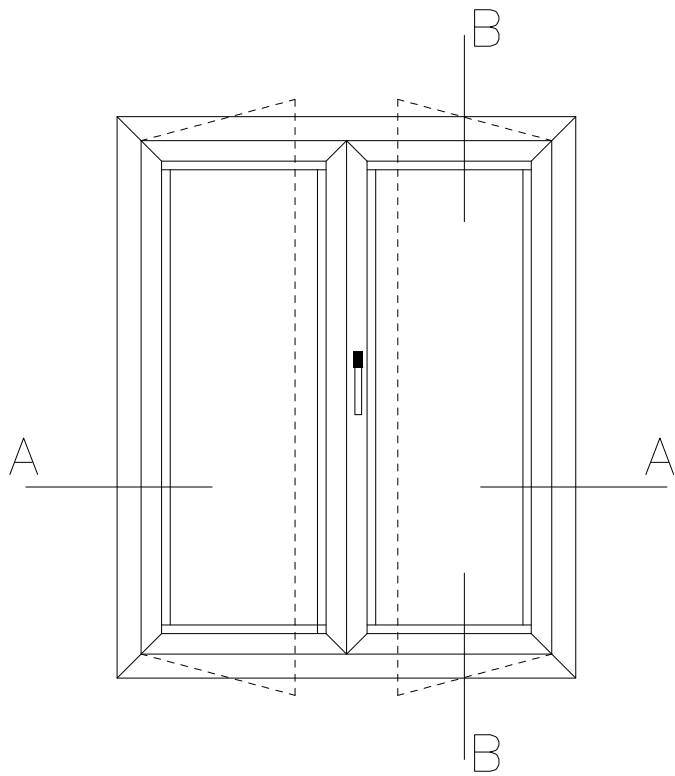

Section B-B

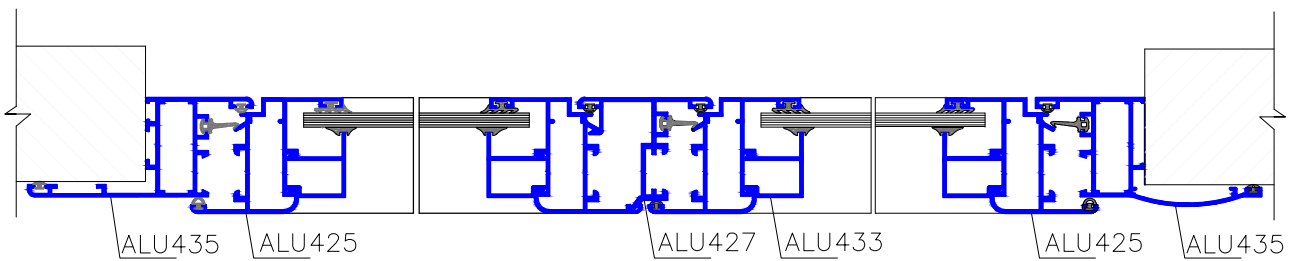

Section A-A

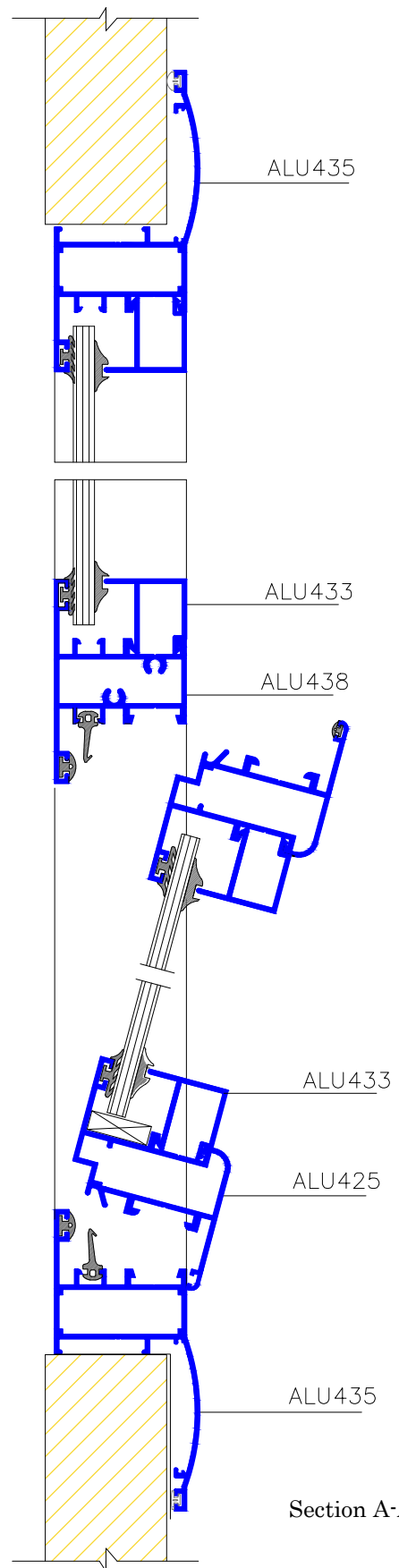
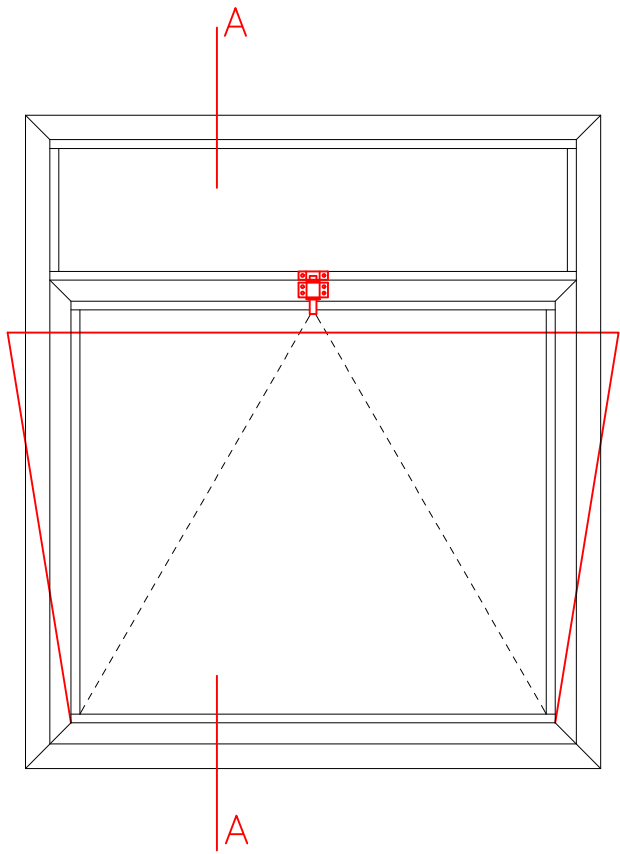

Pivoting Window:

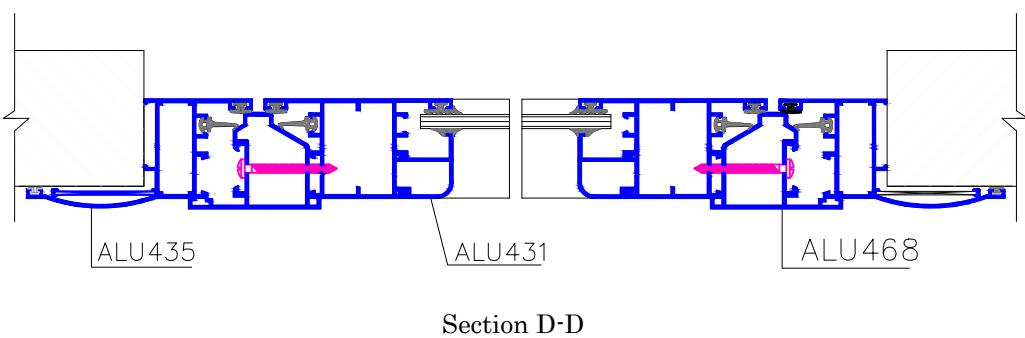
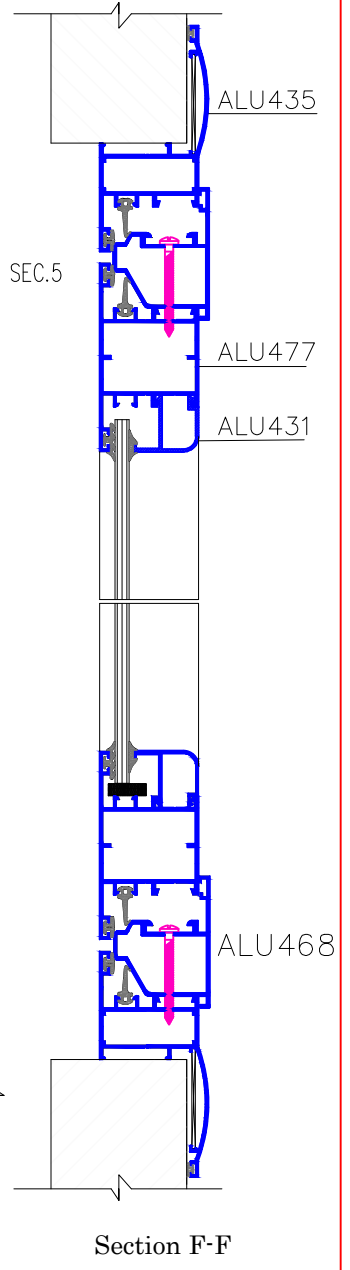
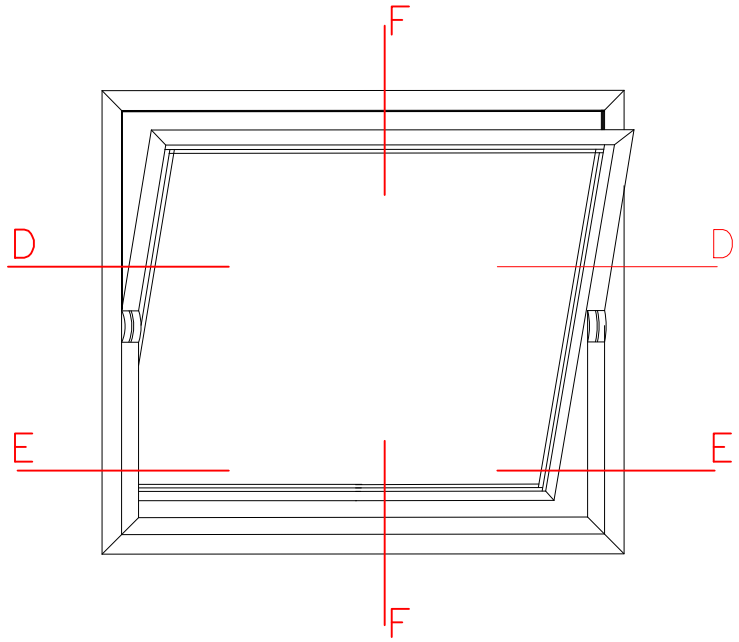

Section D-D

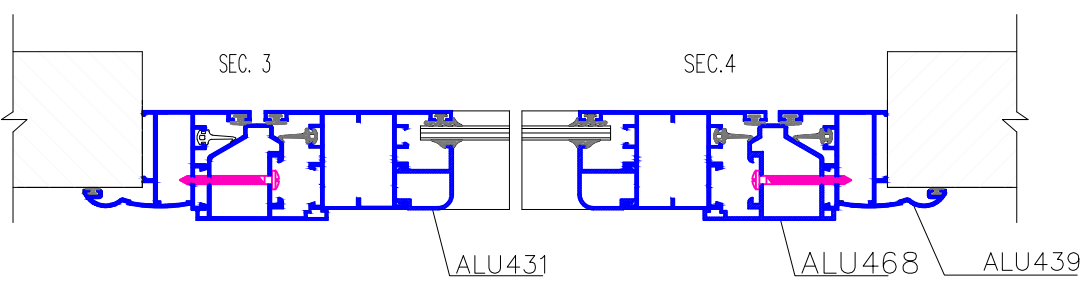

Section E-E

Section F-F

Hinged door:

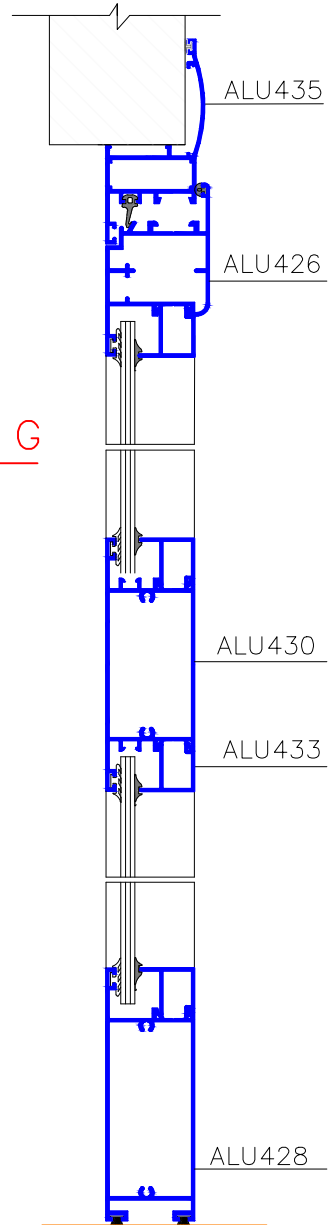
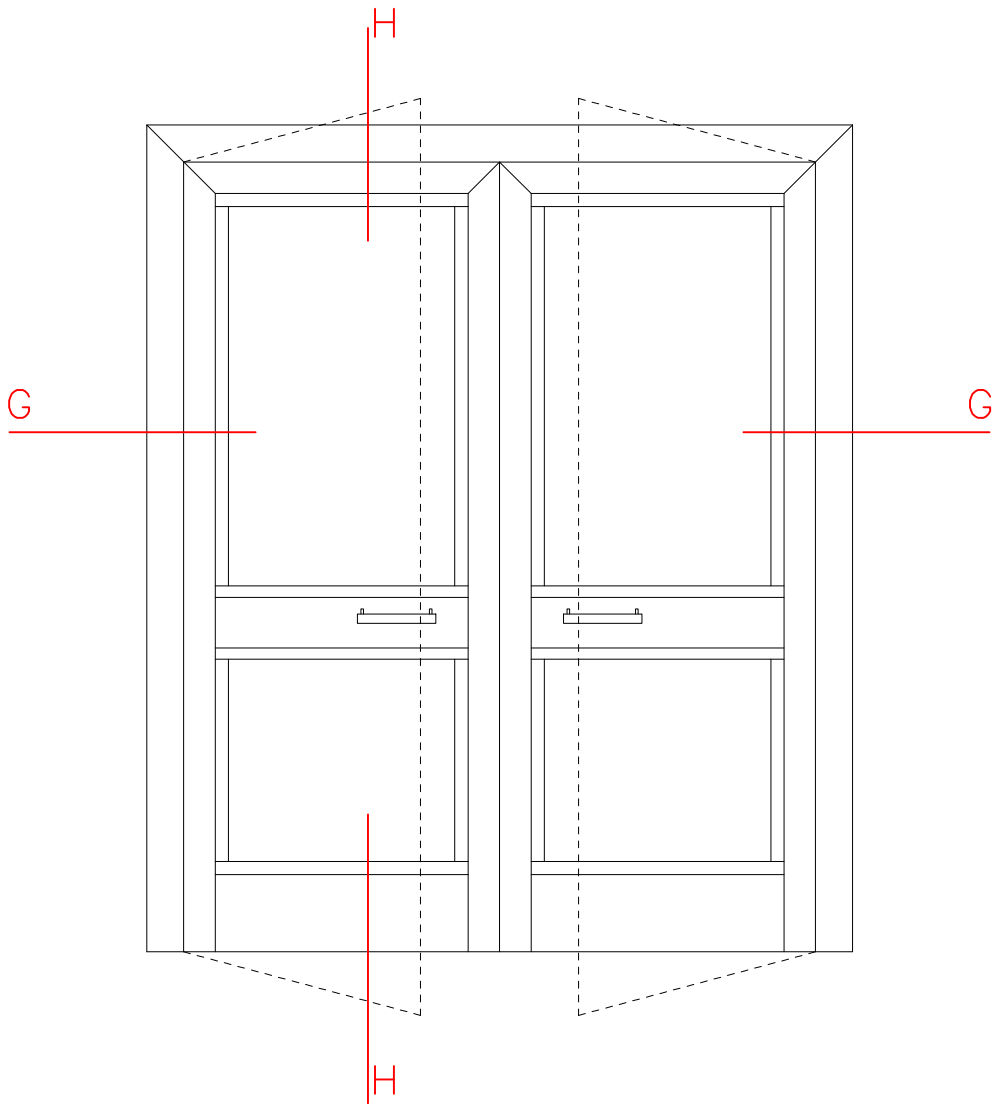

Section H-H

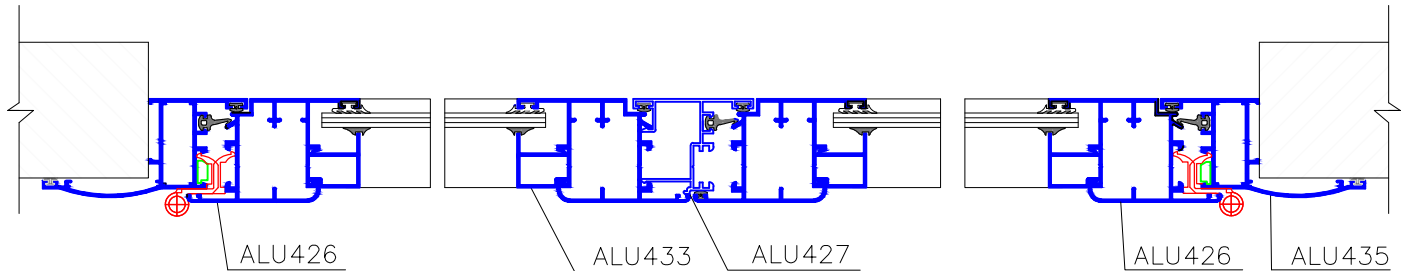

Section G-G

Partition:

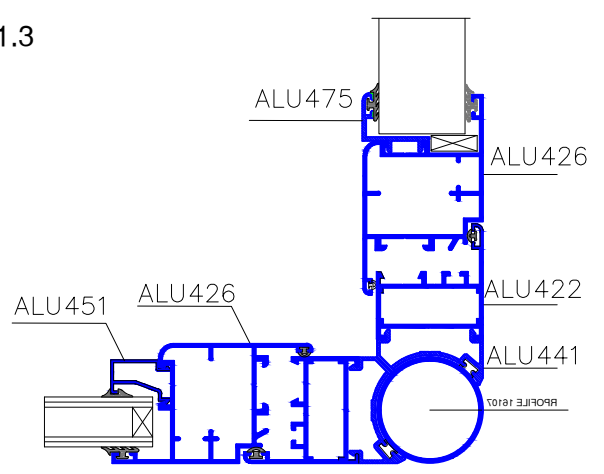
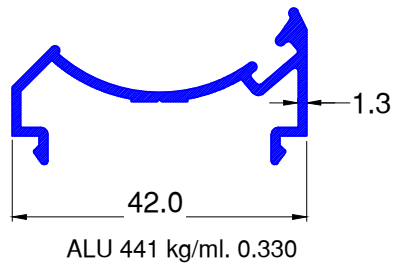
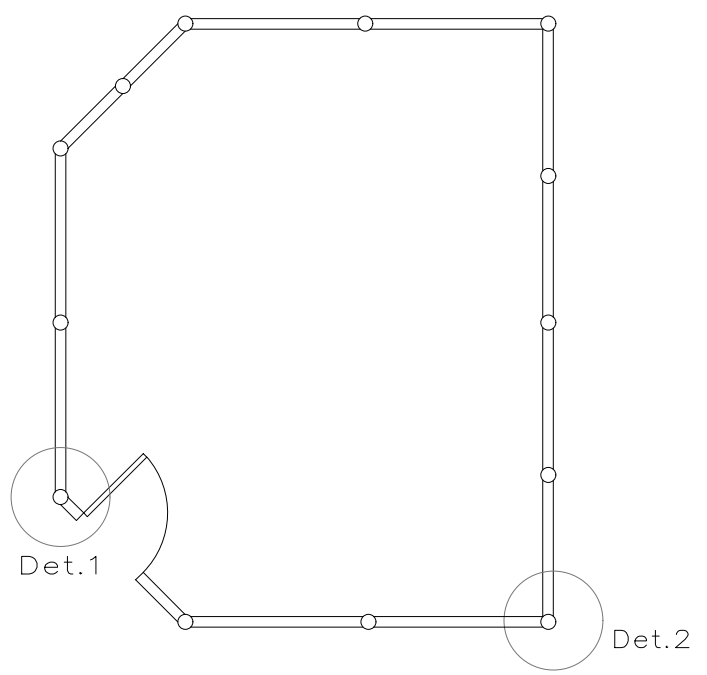
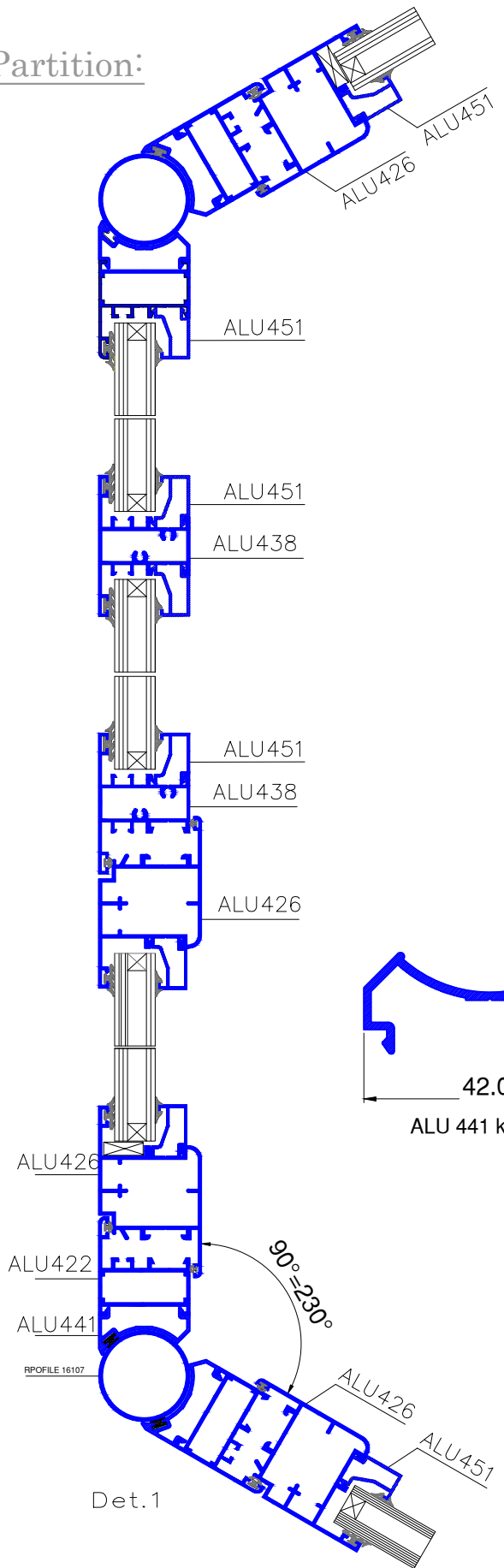

Det.2

Aluminum Profiles:

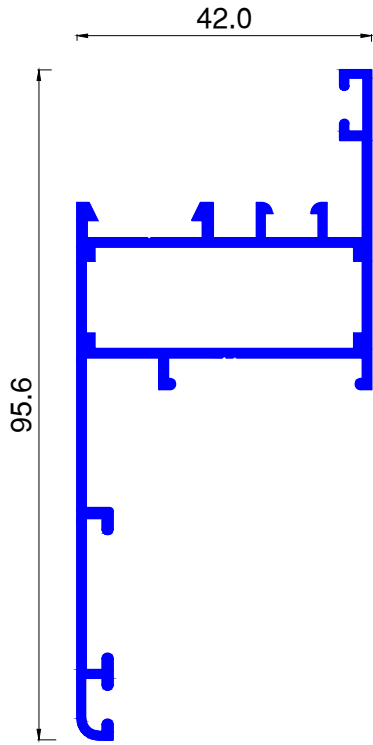

ALU421 kg/ml 0.913

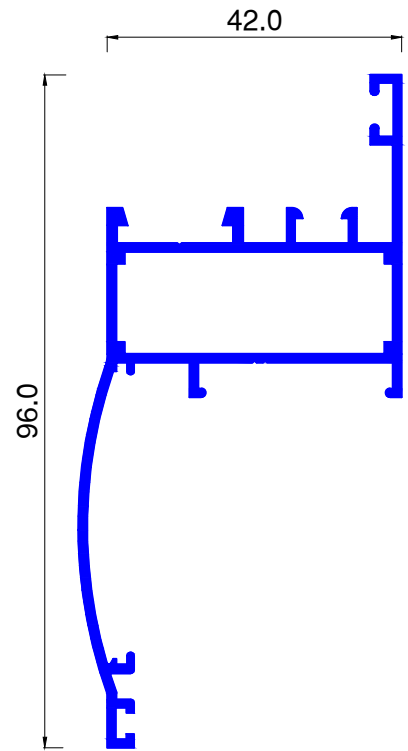

ALU435 kg/ml 0.902

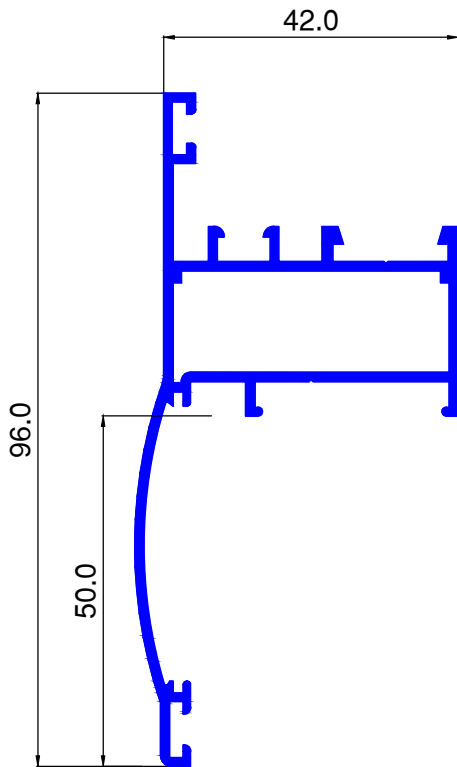

ALU465 Kg/ml. 0.896

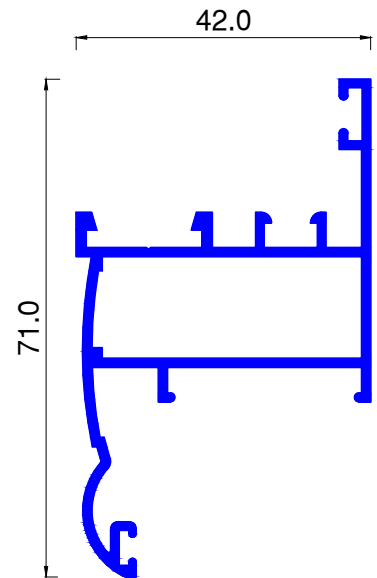

ALU439 kg/ml 0.799



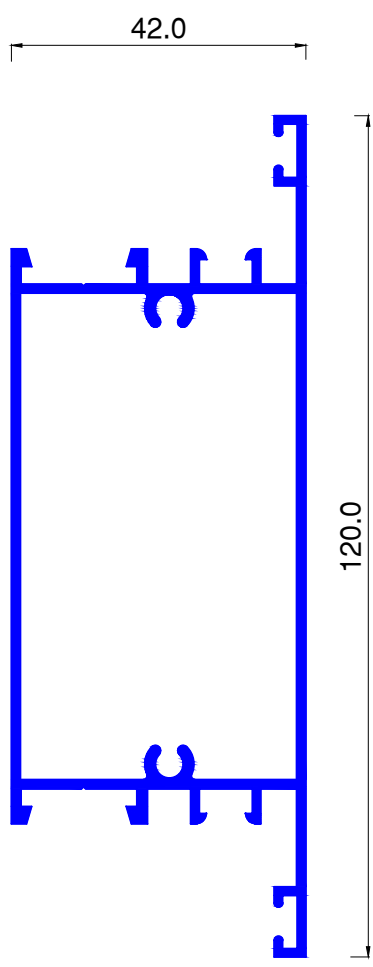

ALU430 kg/ml 1.283

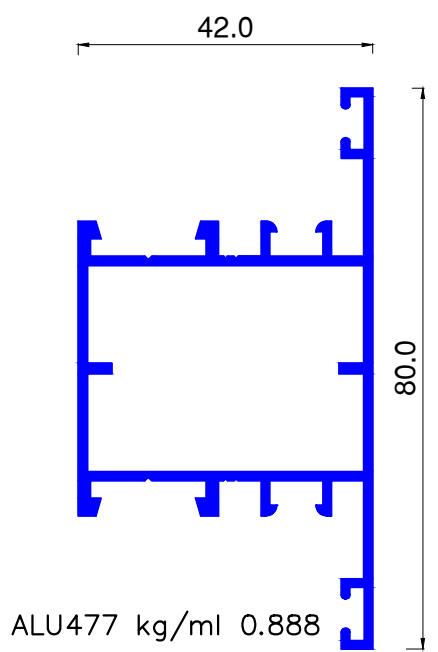

ALU477 kg/ml 0.888

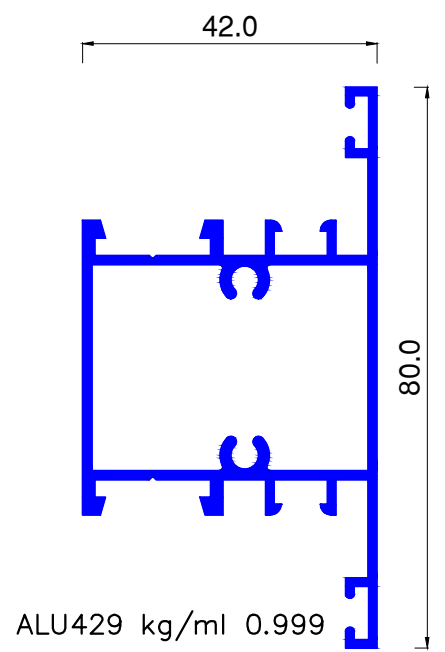

ALU429 kg/ml 0.999

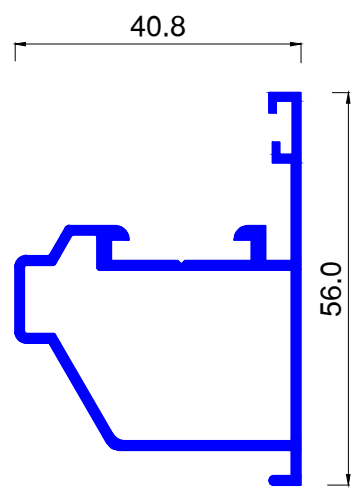

ALU468 kg/ml 0656

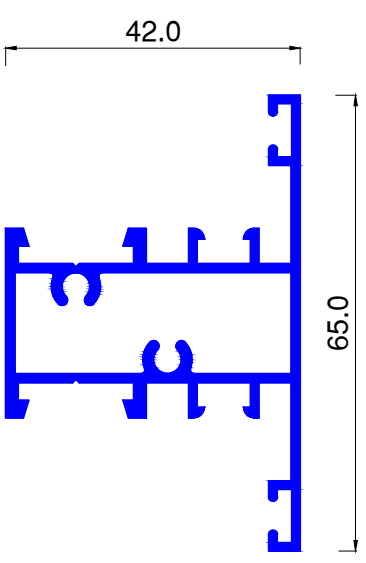

ALU438 kg/ml 0.894

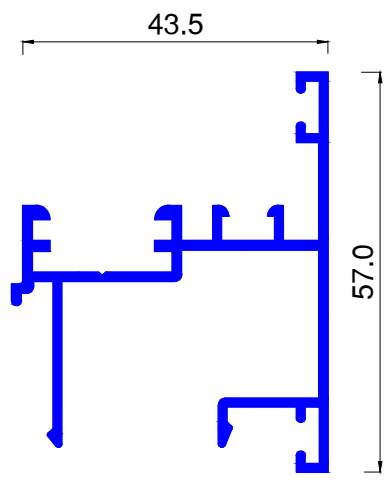

ALU427 Kg/ml 0.697

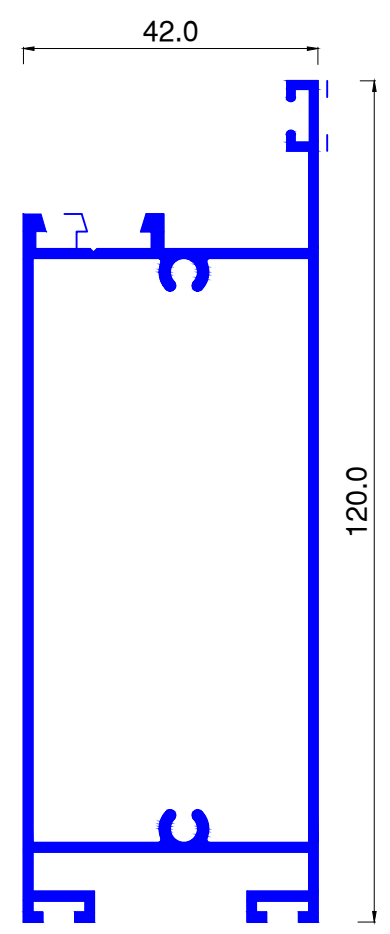

ALU428 kg/ml 1.301

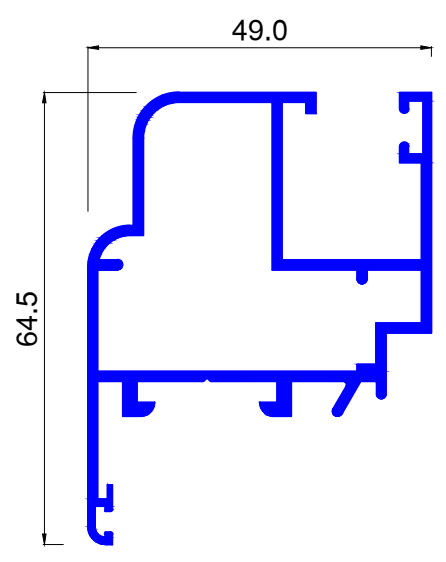

ALU436 kg/ml 1.013

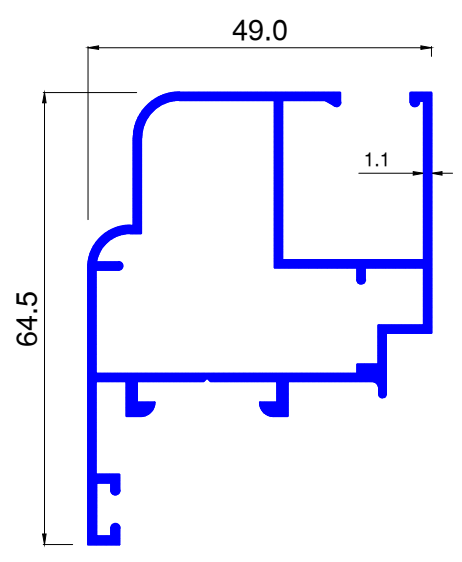

ALU480 kg/ml 0.815

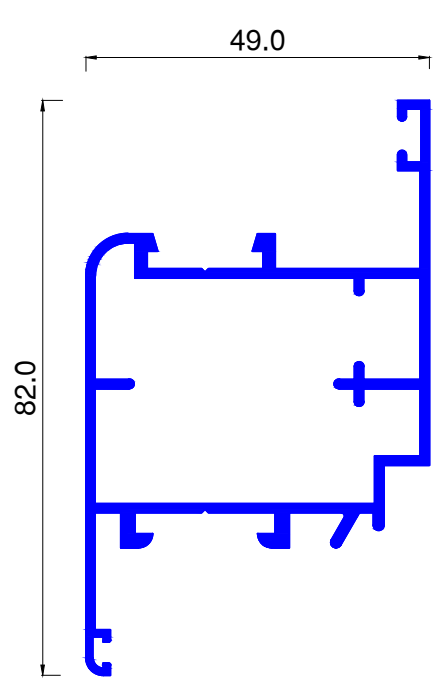

ALU426 kg/ml 1.032

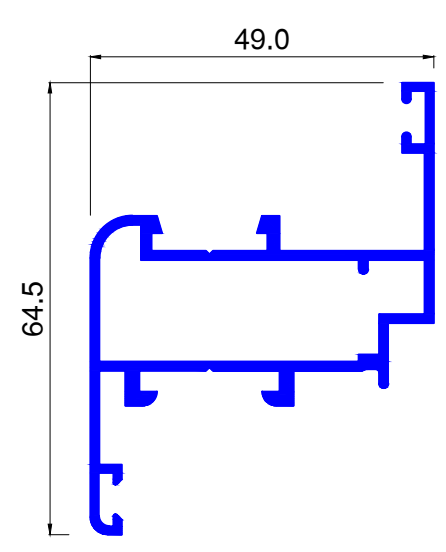

ALU425 kg/ml 0.832

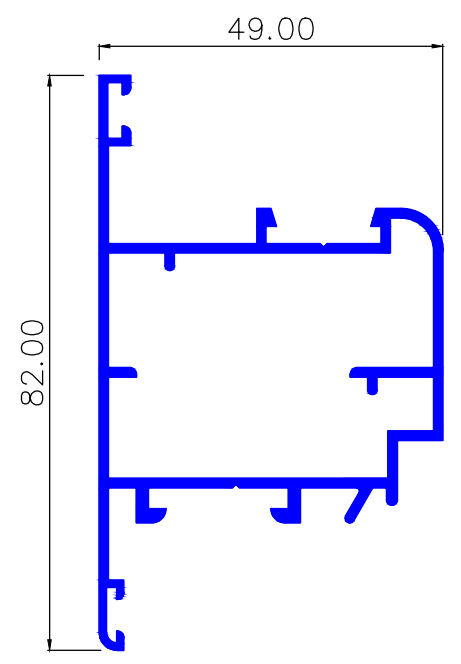

ALU456 kg/ml 0.999

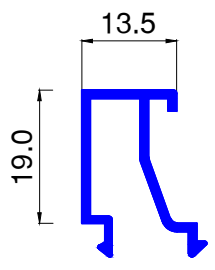

ALU451 kg/ml 0.221

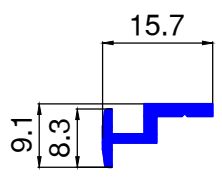

ALU325 kg/ml 0.108

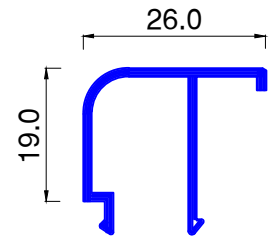

ALU431 kg/ml 0.240

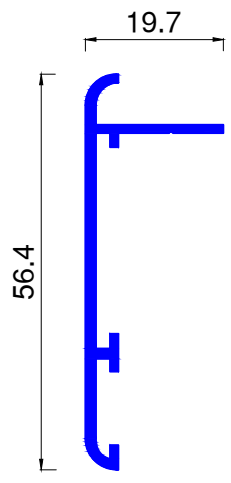

ALU450 kg/ml 0.338

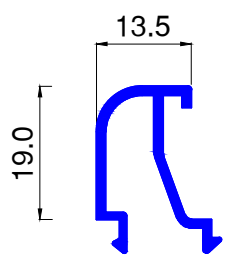

ALU432 Kg/ml 0.221

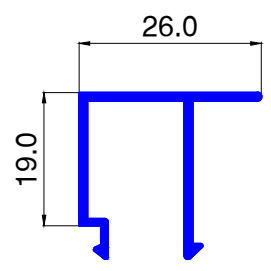

ALU433 kg/ml 0.243

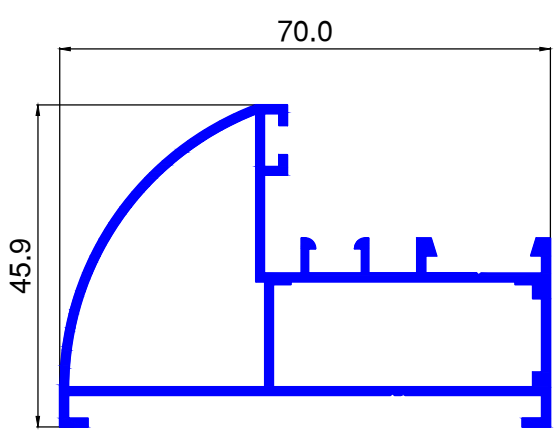

ALU457 Kg/ml. 0.896

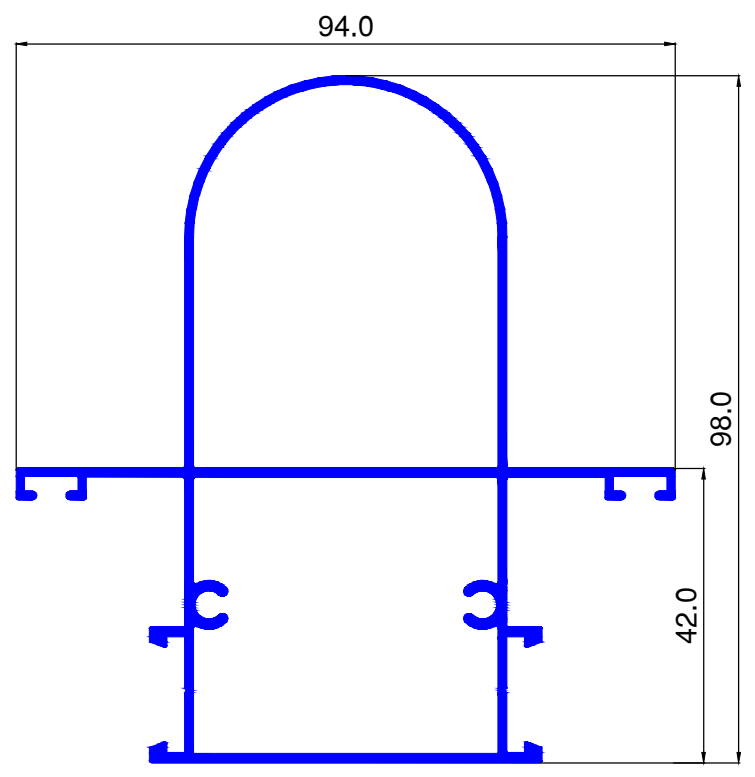

ALU453 Kg/ml. 1.480

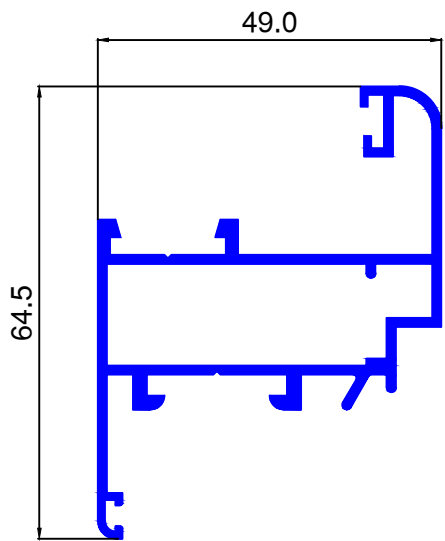

ALU418 kg/ml 0.878

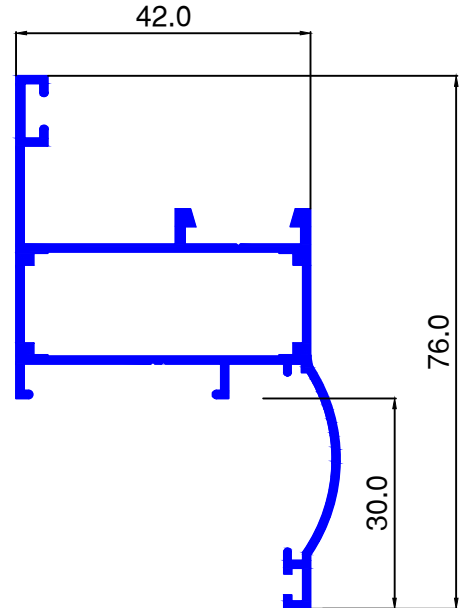

ALU419 kg/ml 0.702

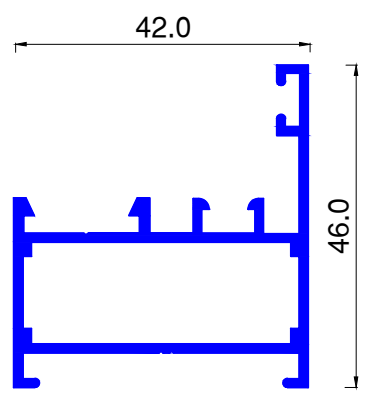

ALU422 kg/ml 0.672

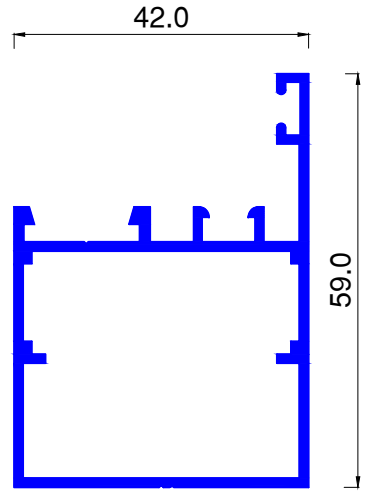

ALU449 kg/ml 0.772

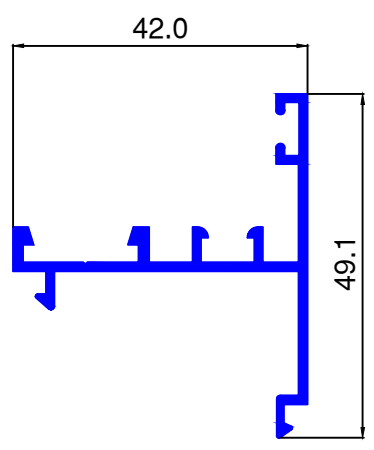

ALU458 kg/ml 0.467

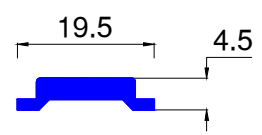

NC1459 kg/ml. 0.162

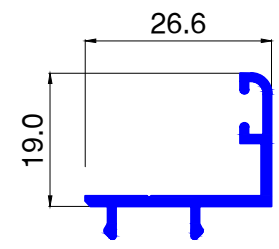

ALU475 kg/ml 0.230