

2019

MR



ALUMISIR

SLIDING SYSTEM

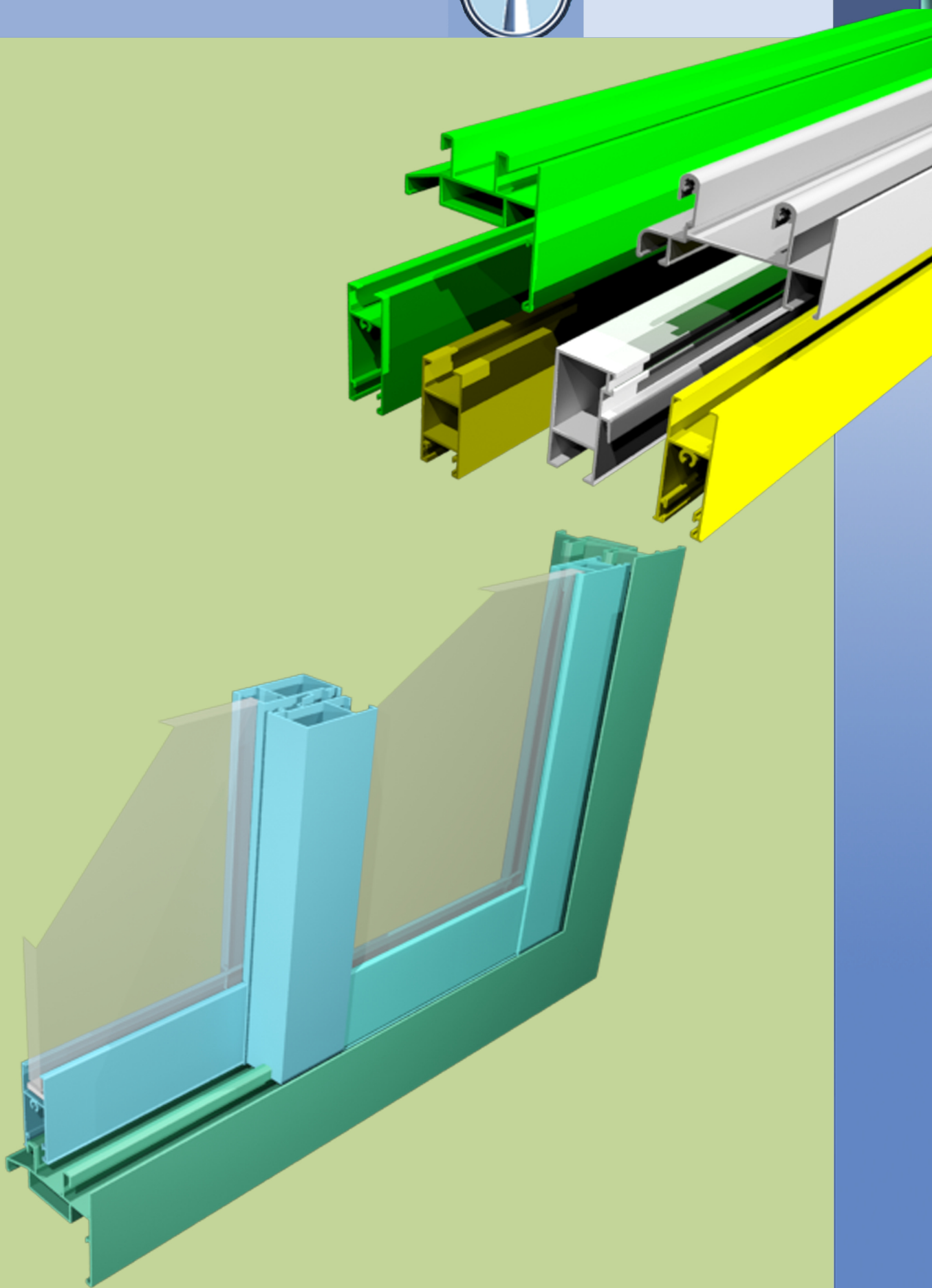



Sliding Window:

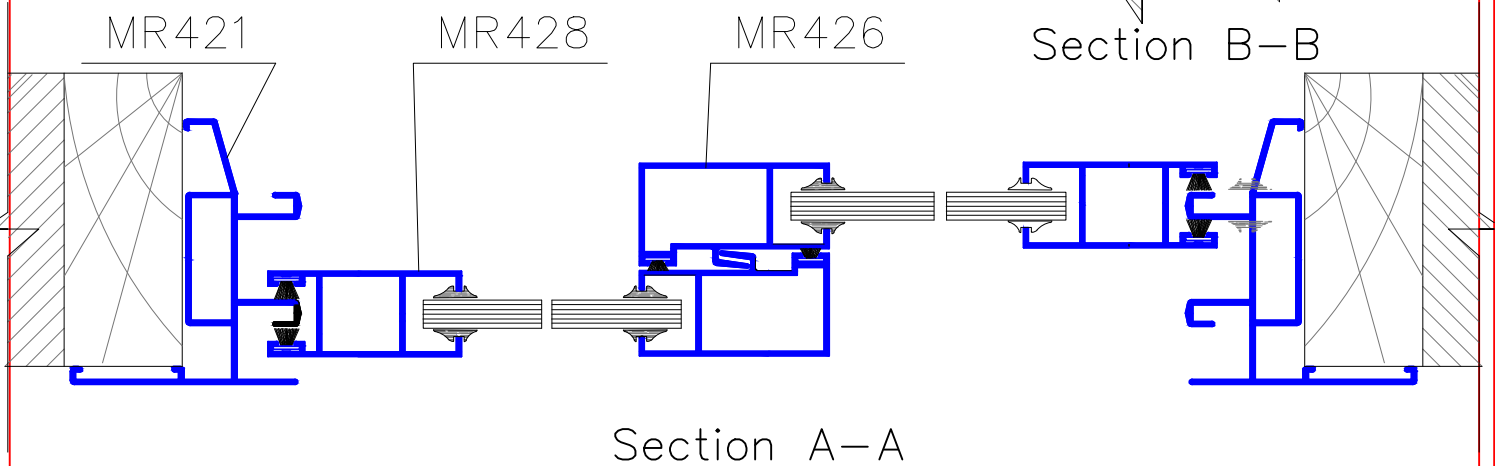
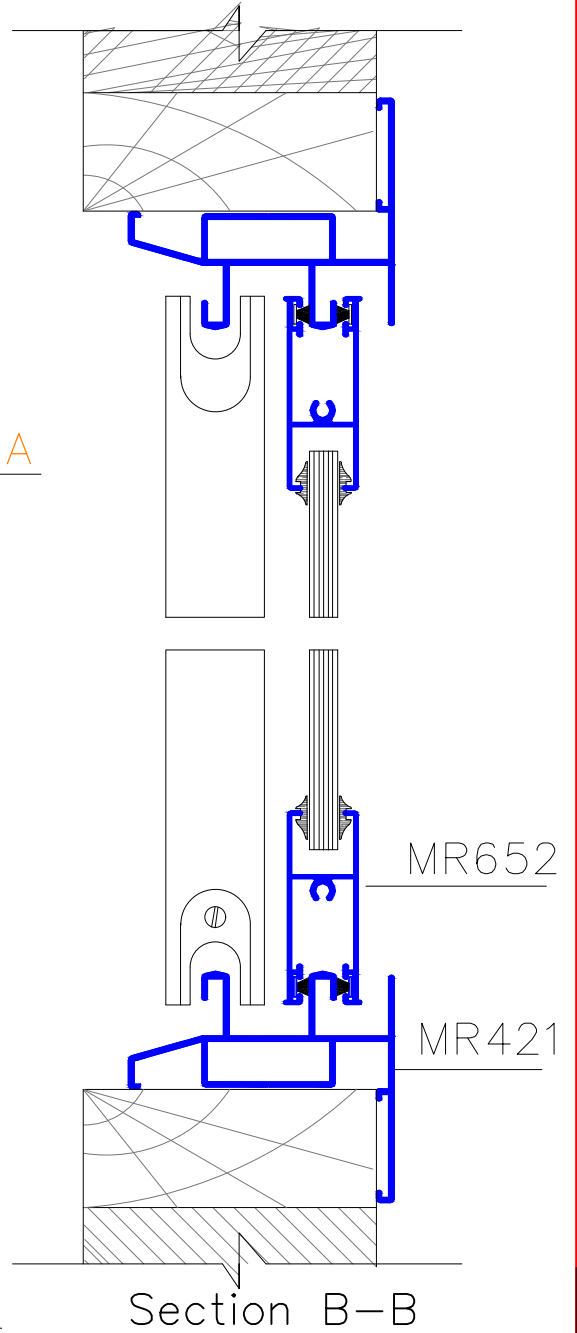
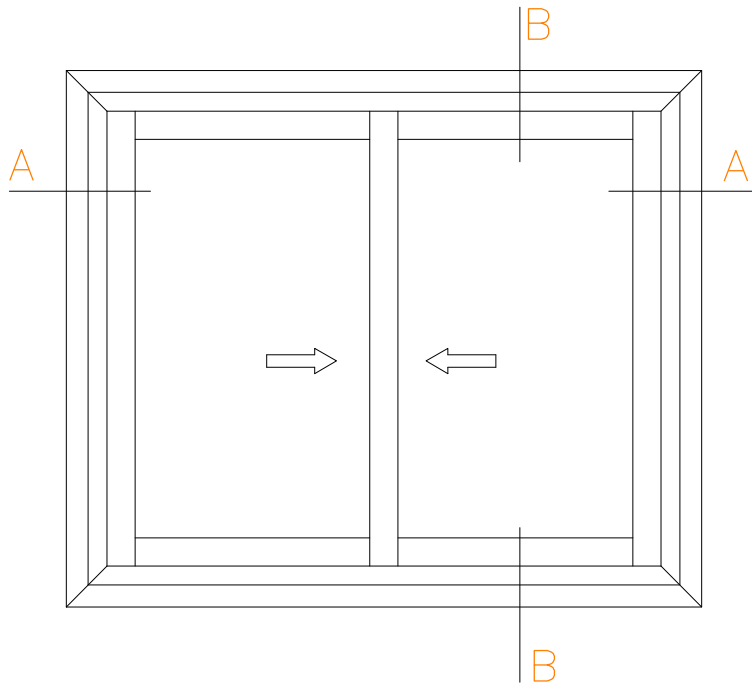

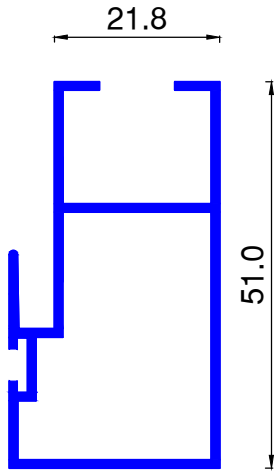

MR10410 0.485 Kg/ml.

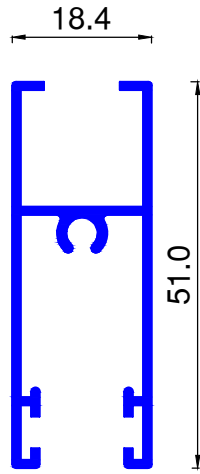

MR10411 0.421 Kg/ml.

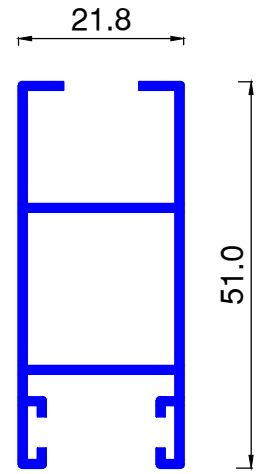

MR10412 0.454 Kg/ml.

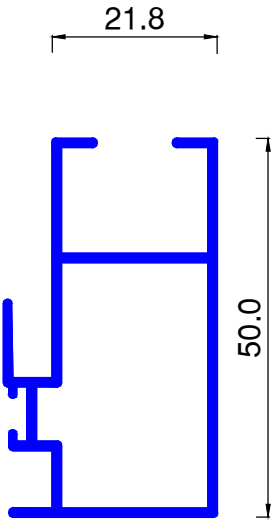

MR418 0.575 Kg/ml.

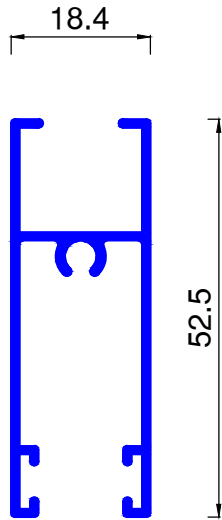

MR1417 0.456Kg/ml.

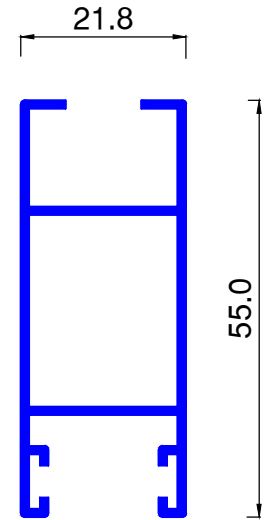

MR1416 0.518 Kg/ml.

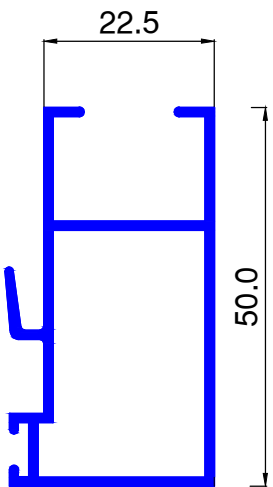

MR426 0.559 Kg/ml.

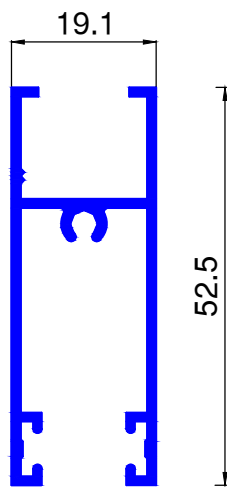

MR427 0.500 Kg/ml.

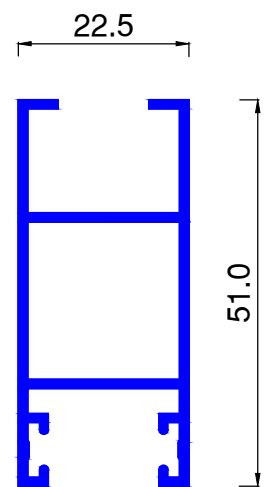

MR428 0.542 Kg/ml.

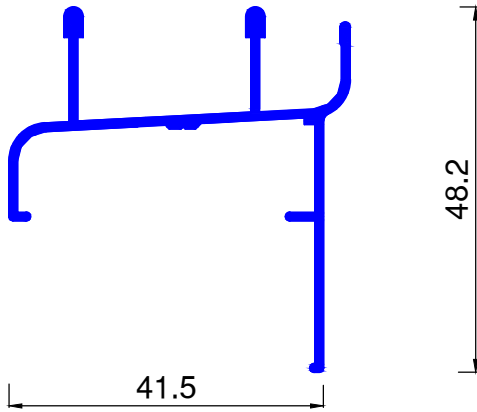

MR10907 0.402 Kg/ml.

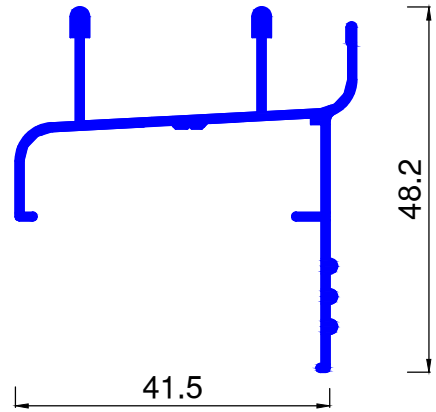

MR901 0.451 Kg/ml.

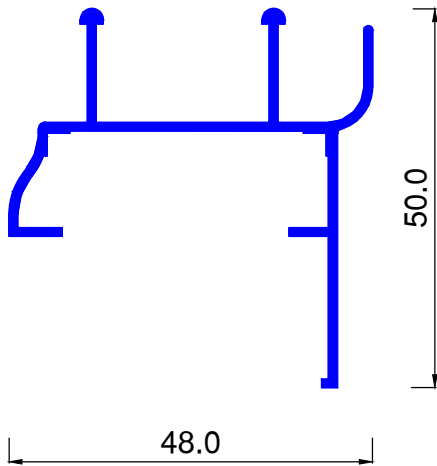

MR170 0.455 Kg/ml.

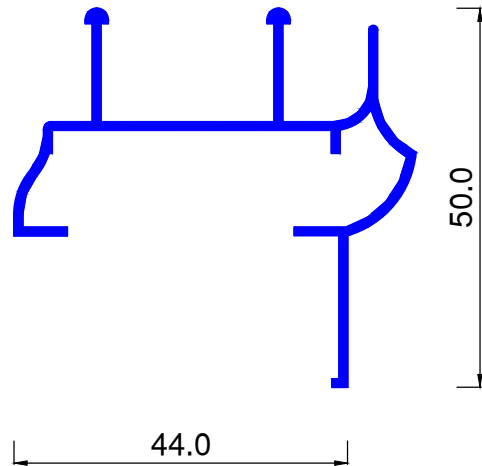

MR165 0.487 Kg/ml.

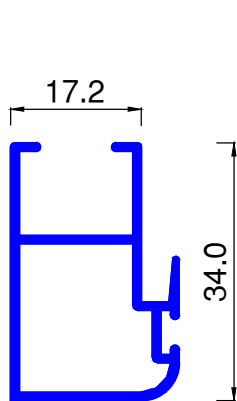

MR903 0.359 Kg/ml.

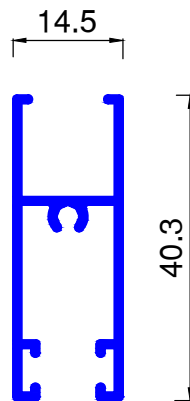

MR902 0.346 Kg/ml.

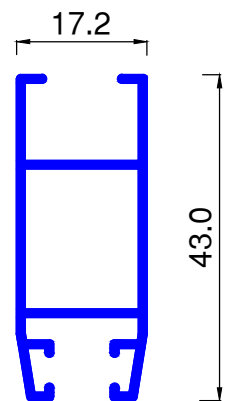

MR904 0.405 Kg/ml.

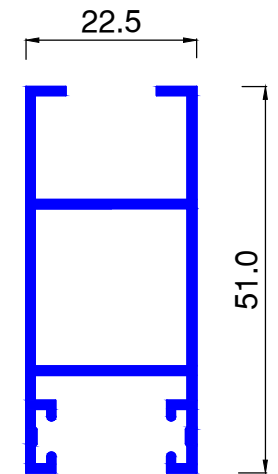
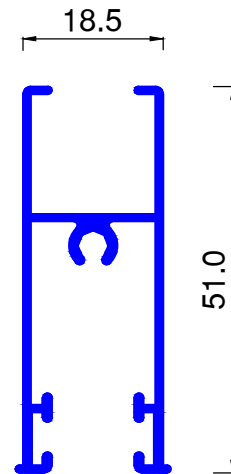
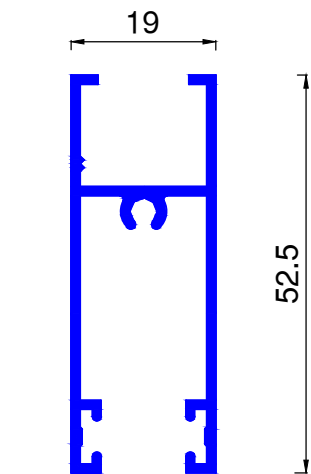
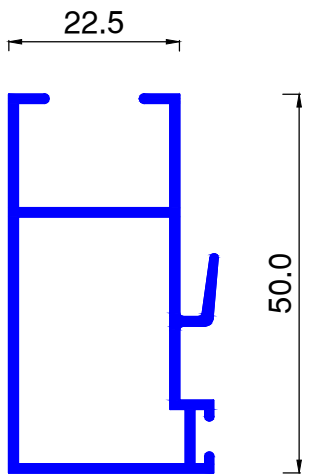
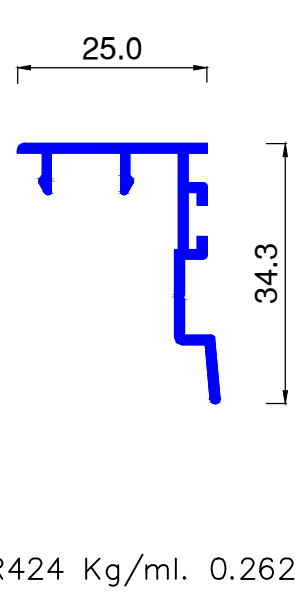
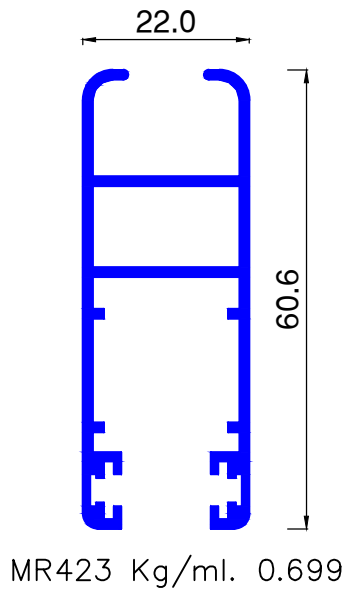
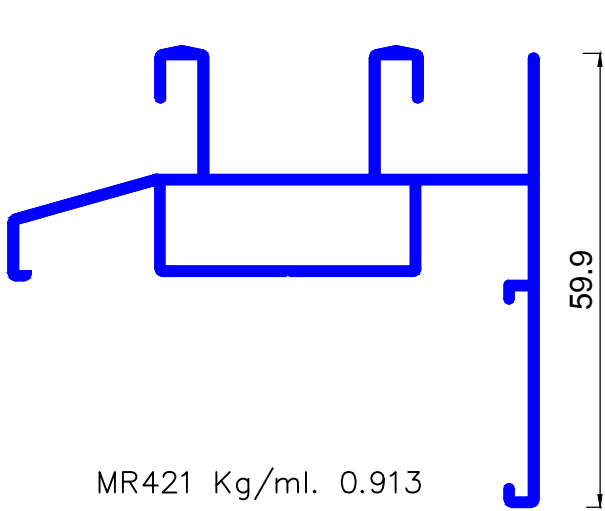
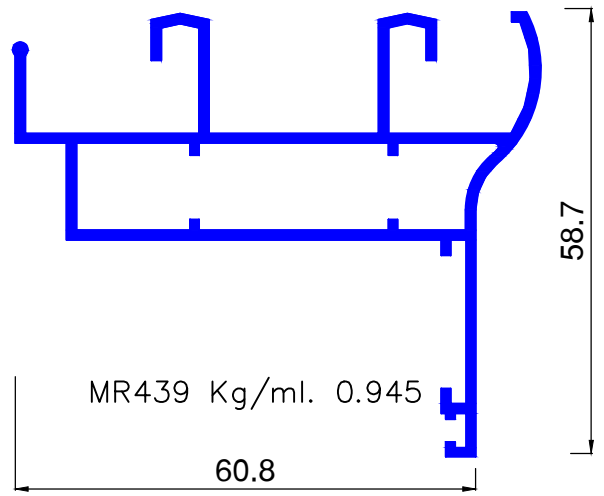
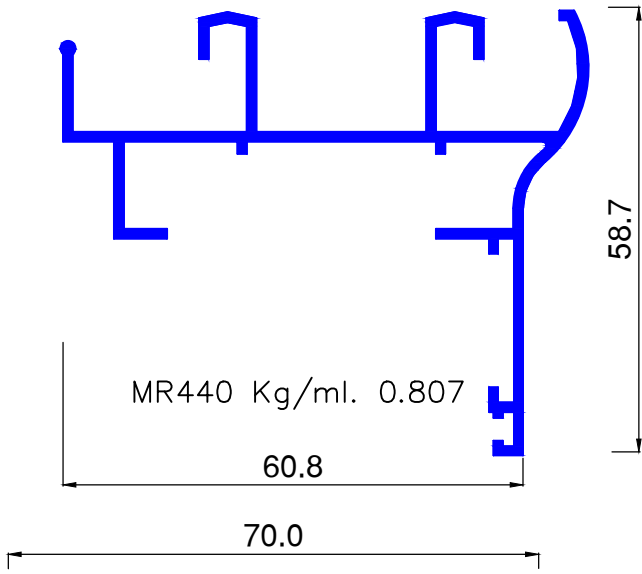

MR426 Kg/ml. 0.559

MR427 Kg/ml. 0.500

MR652 Kg/ml. 0.448

MR428 Kg/ml. 0.542

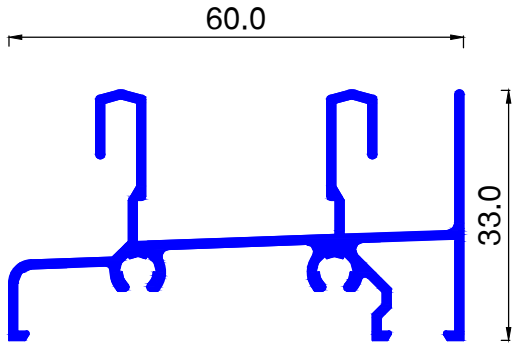

MR10327 0.591 Kg/ml.

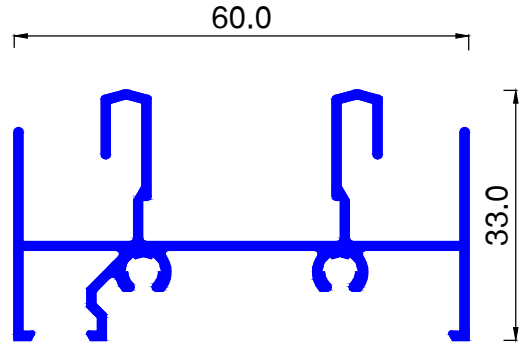

MR10326 0.626 Kg/ml.

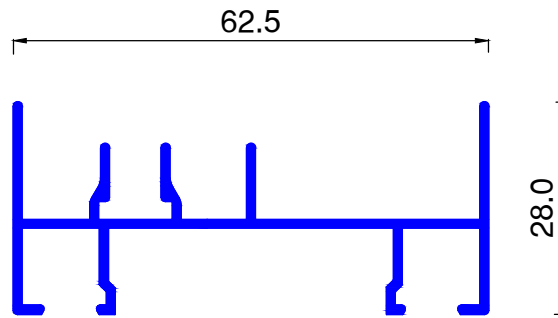

MR10325 0.489 Kg/ml.

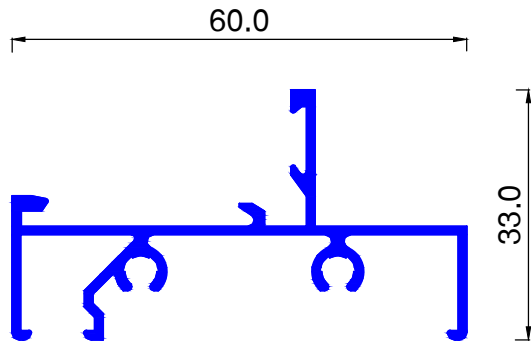

MR10467 0.491 Kg/ml.

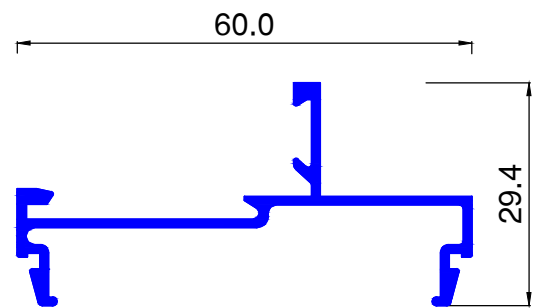

MR10468 0.351 Kg/ml.

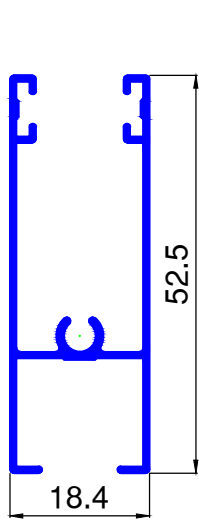

MR30417 Kg/ml. 0.367

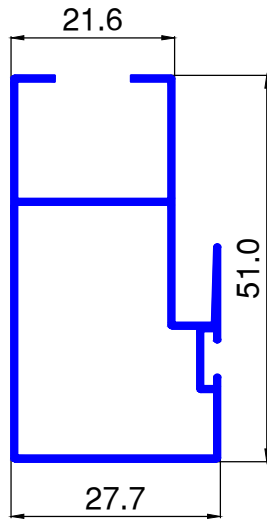

MR30410 Kg/ml. 0.419

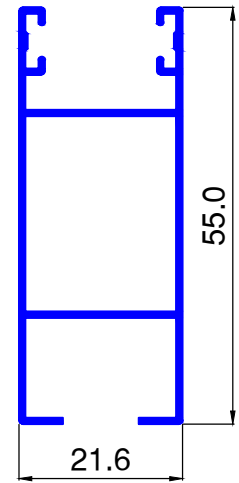

MR30416 Kg/ml. 0.408

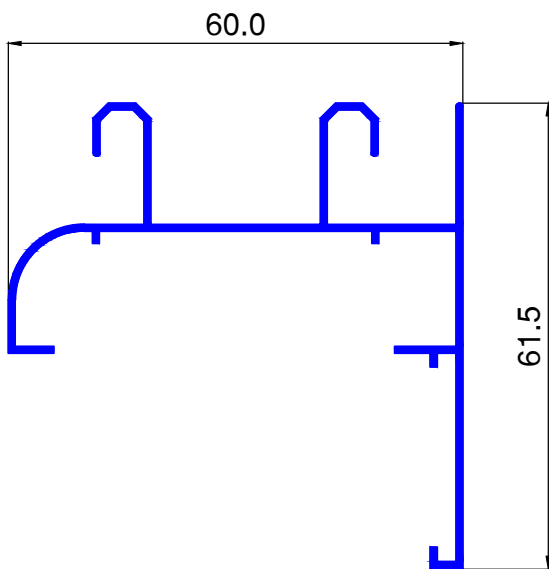

MR30413 Kg/ml. 0.510

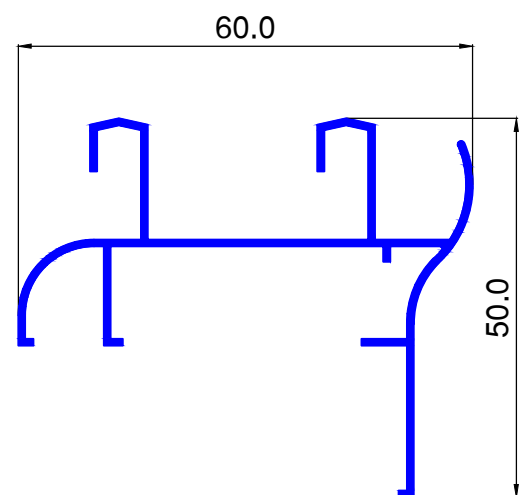

MR30446 Kg/ml. 0.473

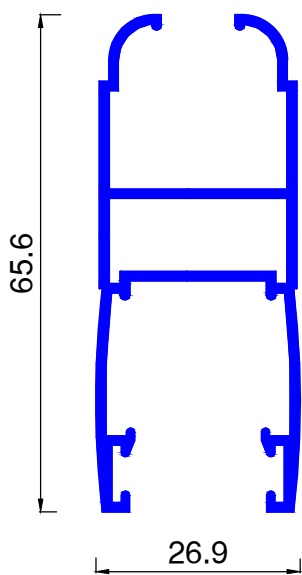
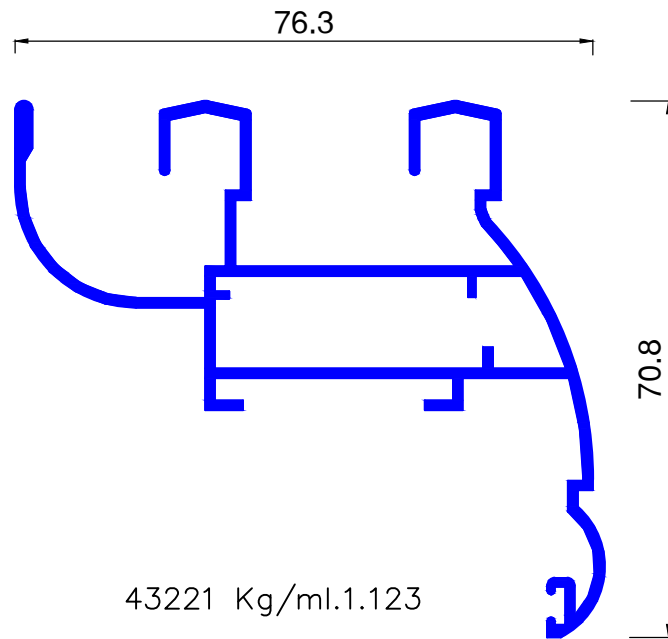

43222 Kg/ml. 0.707

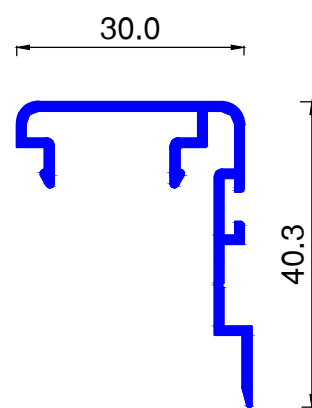

43297 Kg/ml. 0.346