

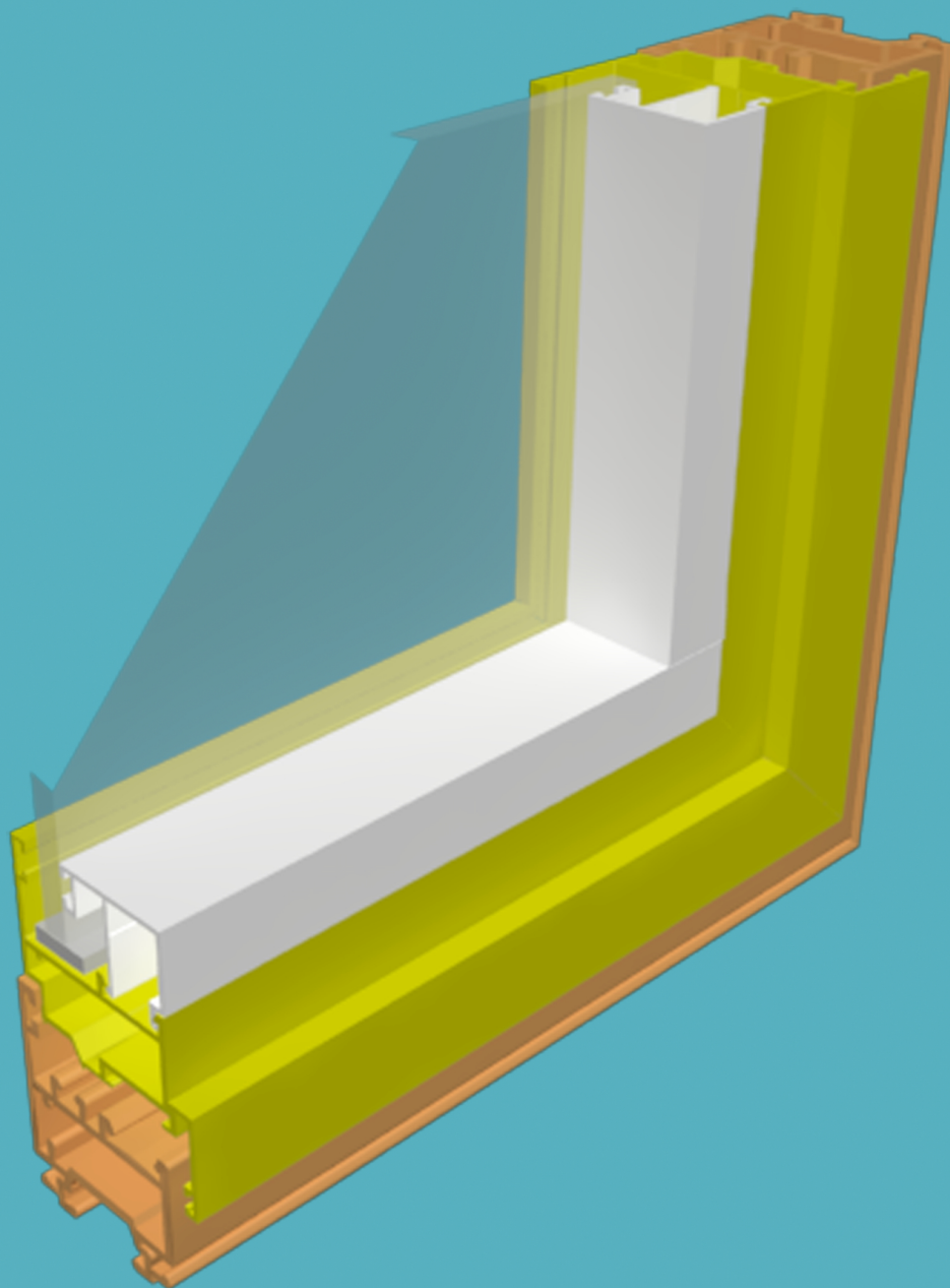

MT

HINGGED SYSTEM

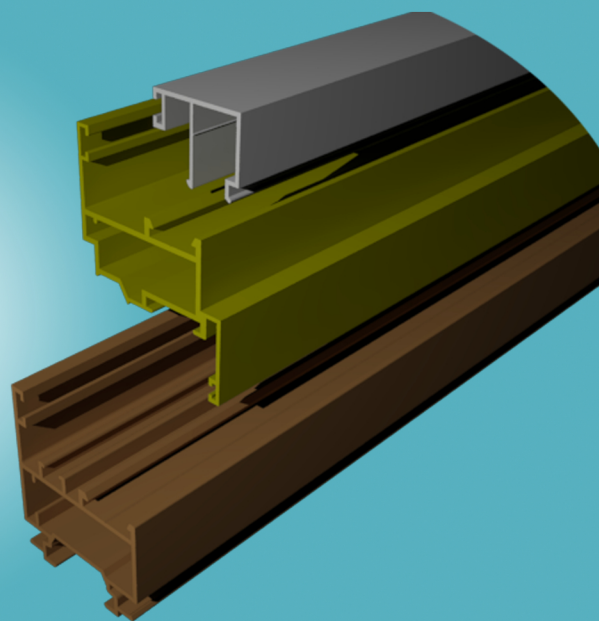

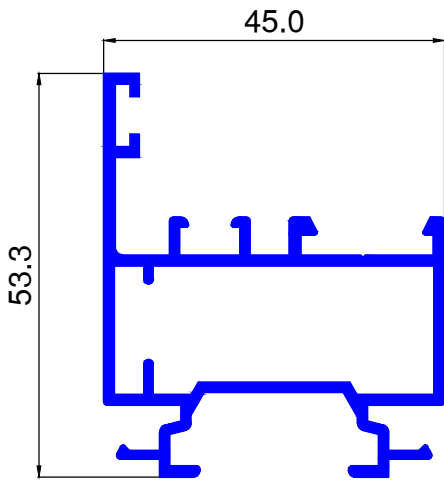

MT369 0.875 kg/ml.

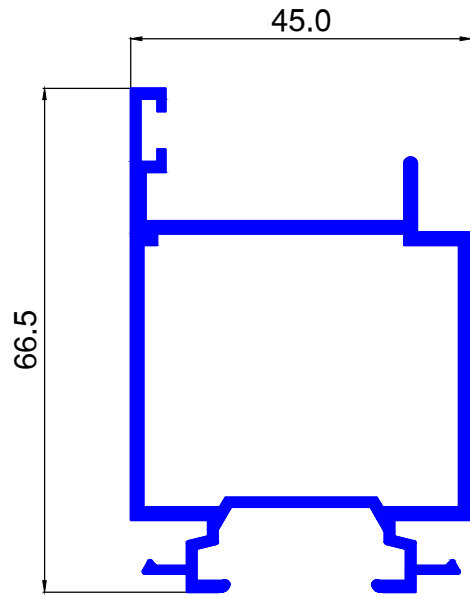

MT361 1.034 kg/ml.

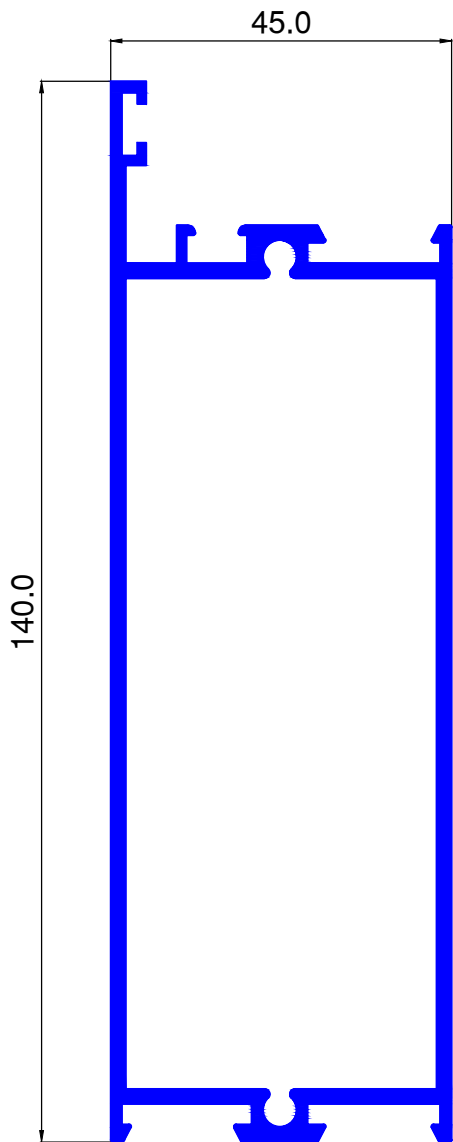

MT380 2.039 kg/ml

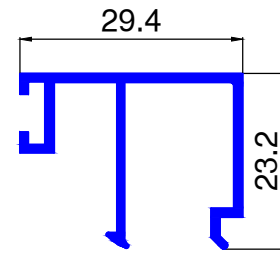

MT366 0.292 kg/ml.

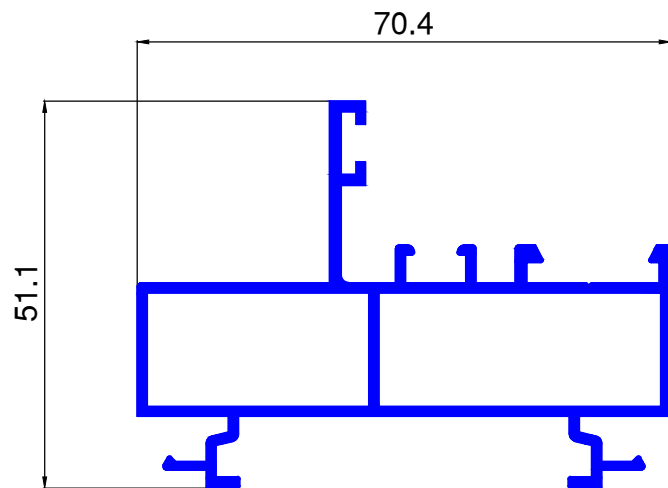

MT360 1.026 kg/ml.

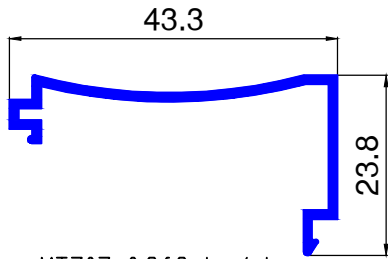

MT707 0.262 kg/ml.

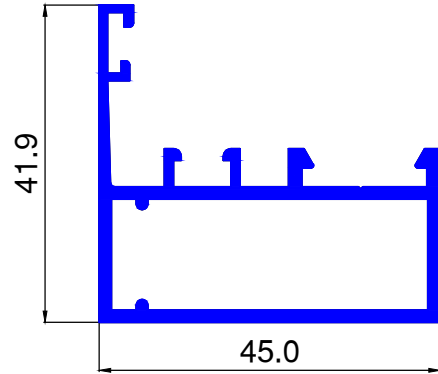

MT709 0.732 kg/ml.

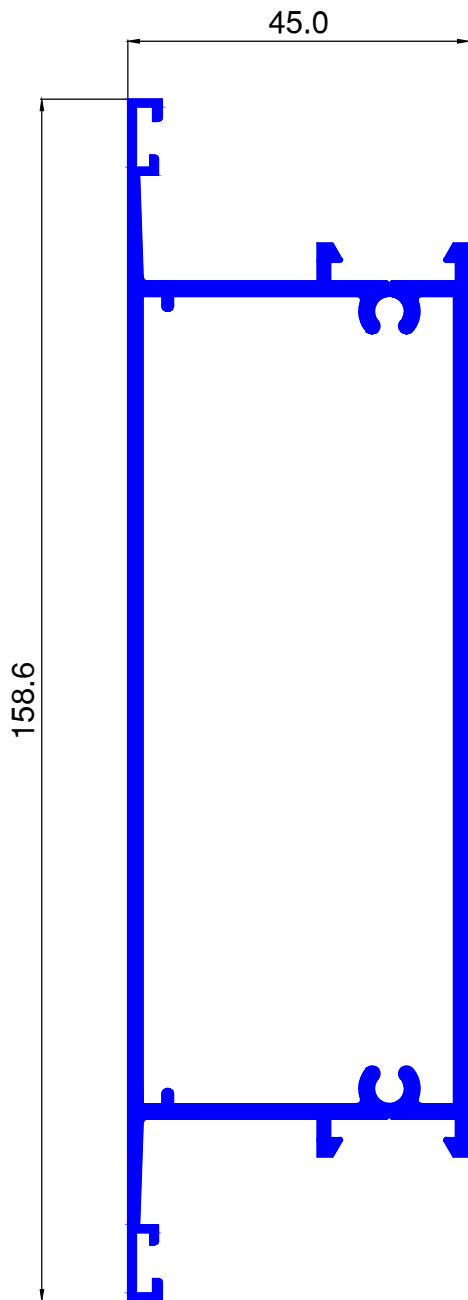

MT704 2.133 kg/ml.

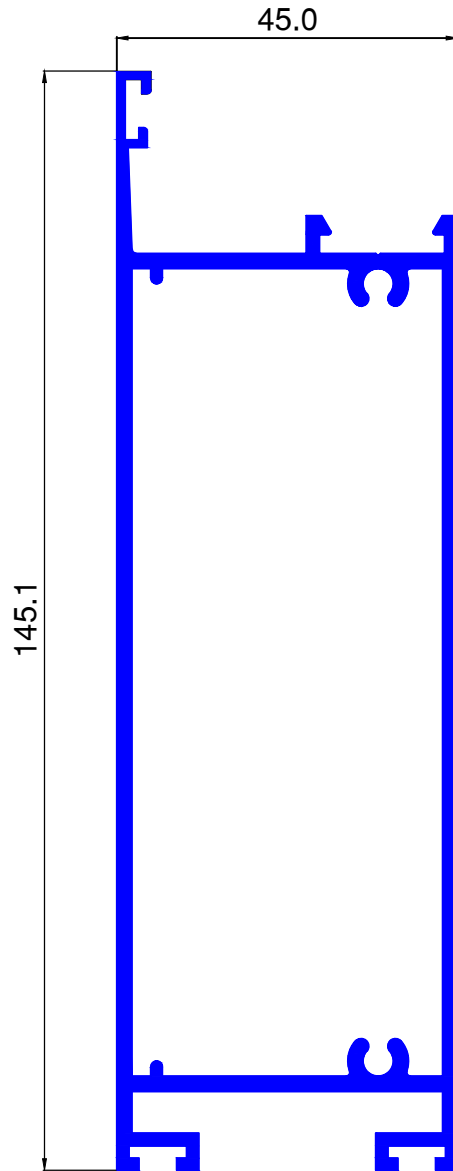

MT703 2.187 kg/ml.

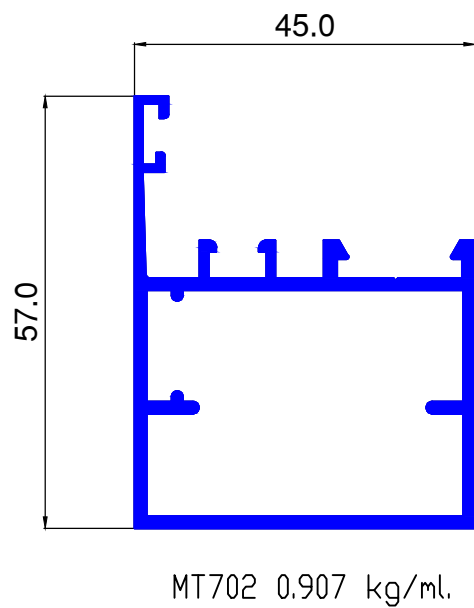
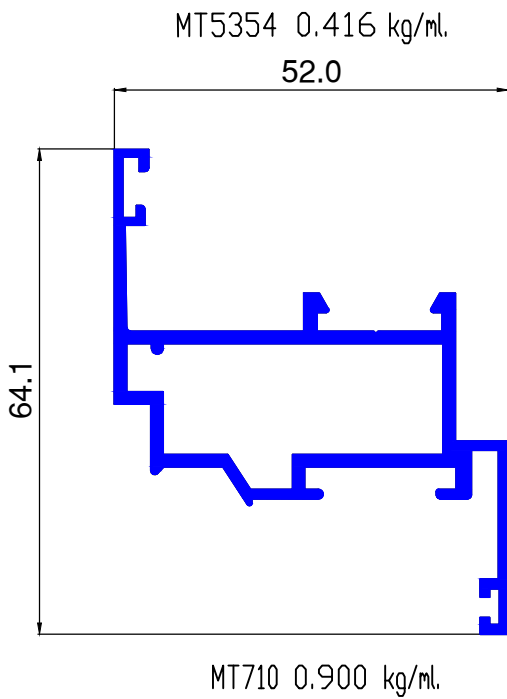
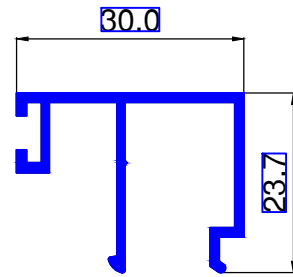
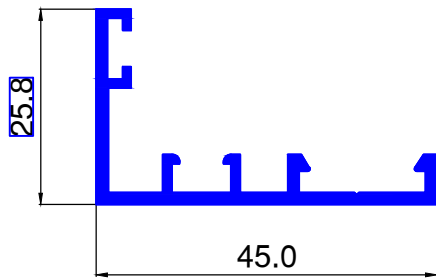
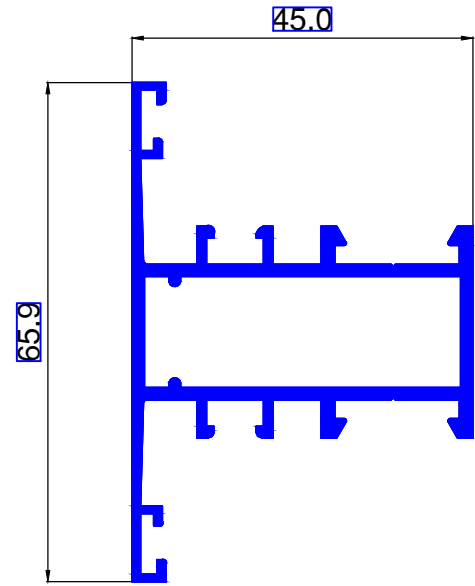
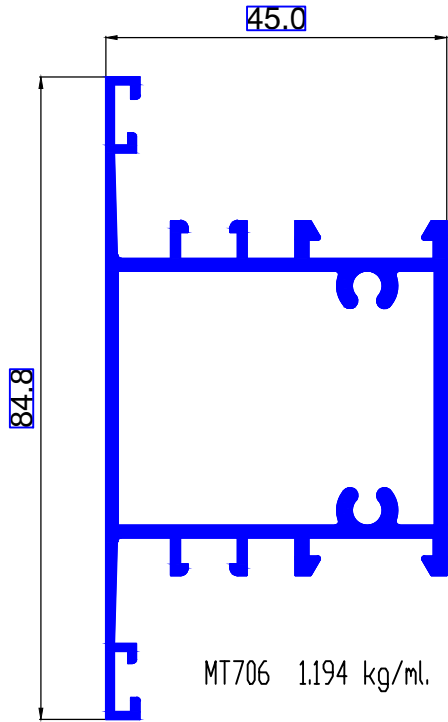

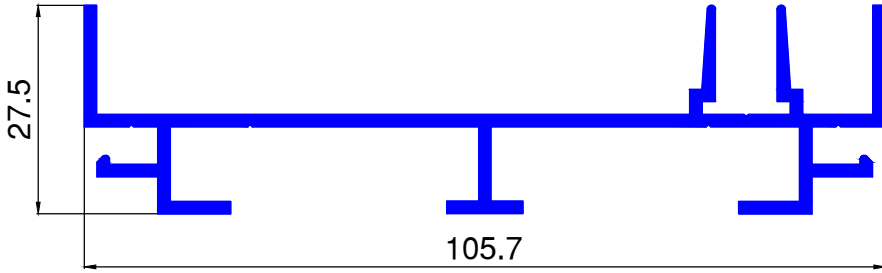

MT5287 1.037 kg/ml

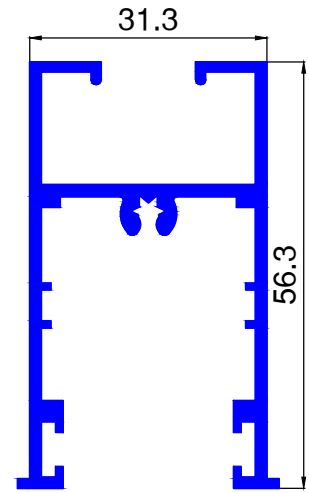

MT5374 0.829 kg/ml.

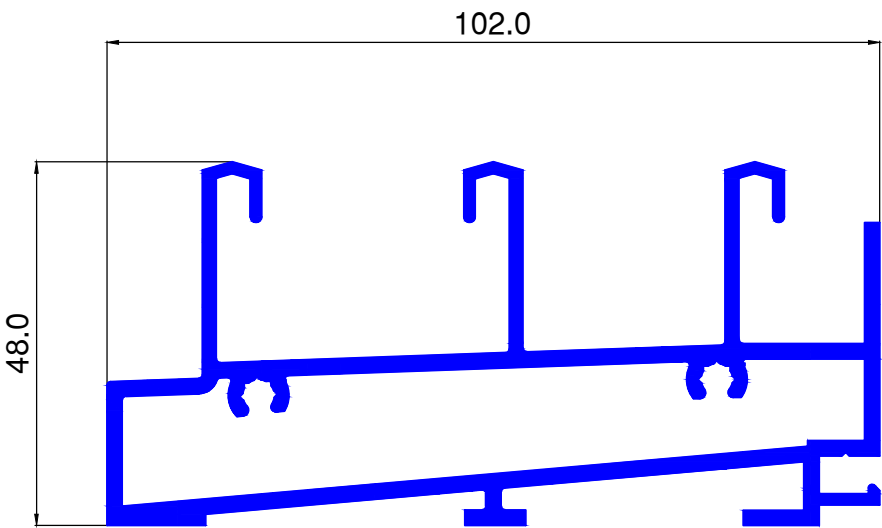

MT5286 2.192 kg/ml.

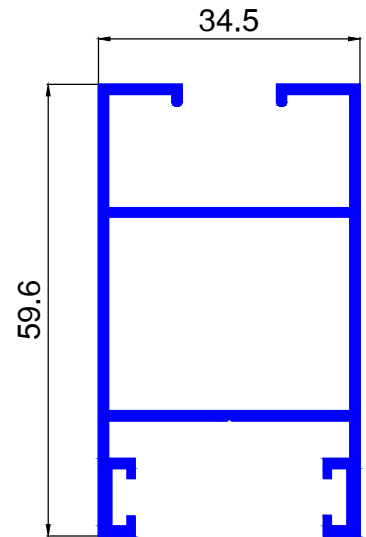

MT5373 0.791 kg/ml.

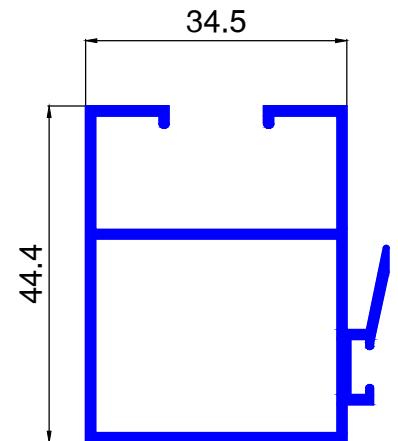

MT5372 0.689 kg/ml.

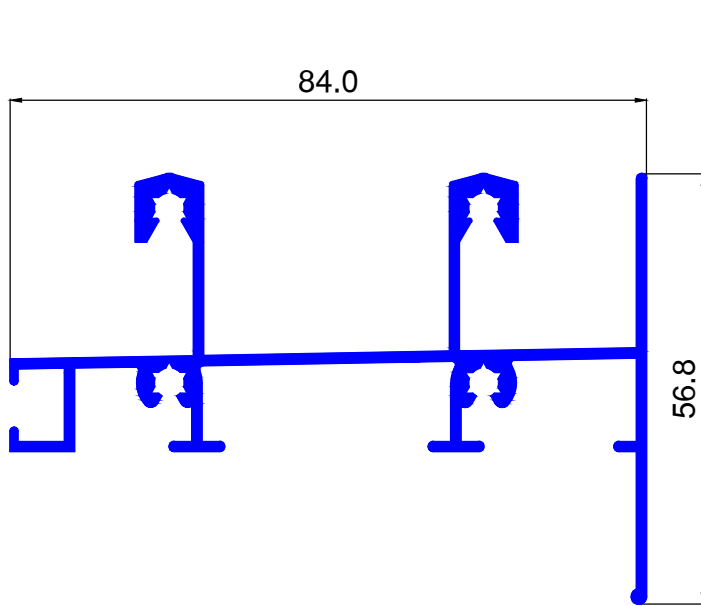

MT5370 1.180 kg/ml.

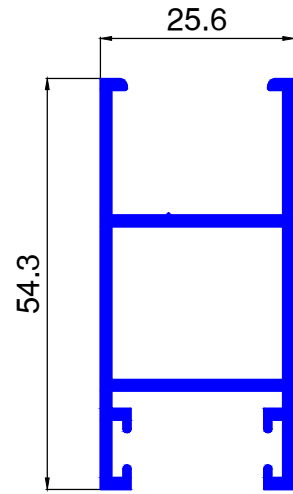

MT752 0.697 kg/ml.

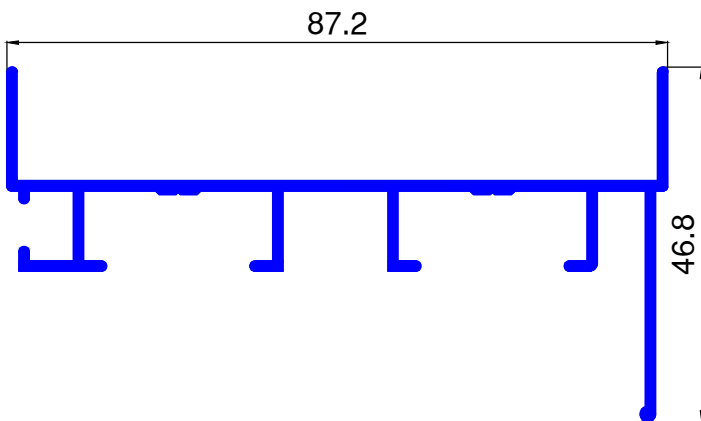

MT5371 0.759 kg/ml.

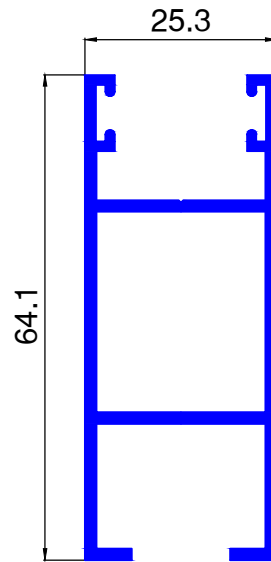

MT5274 0.780 kg/ml.

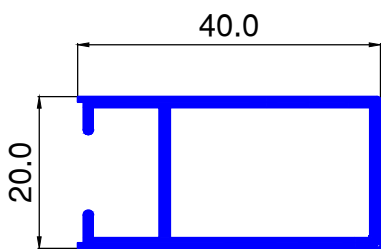

MT273 0.451 kg/ml.

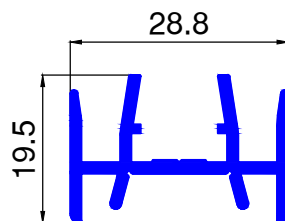

MT5364 0.381 kg/ml.

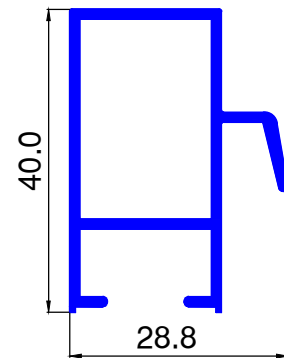

MT227 0.486 kg/ml.

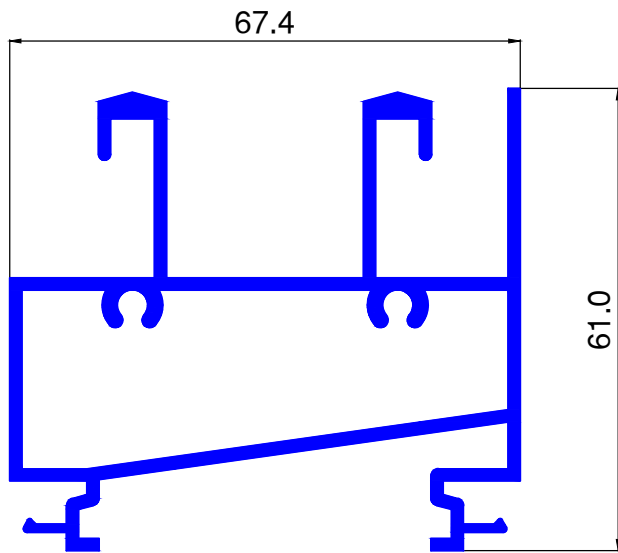

MT209 1.577 kg/ml.

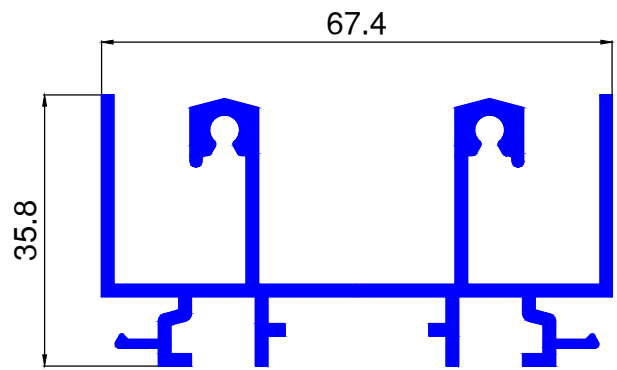

MT208 1.161kg/ml.

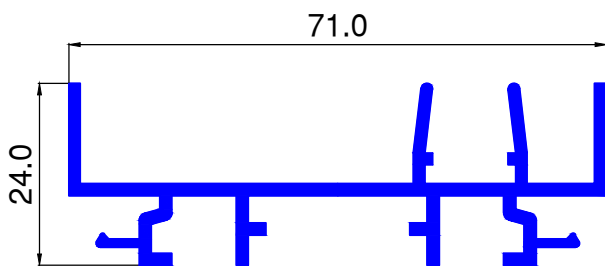

MT206 0.788 kg/ml.

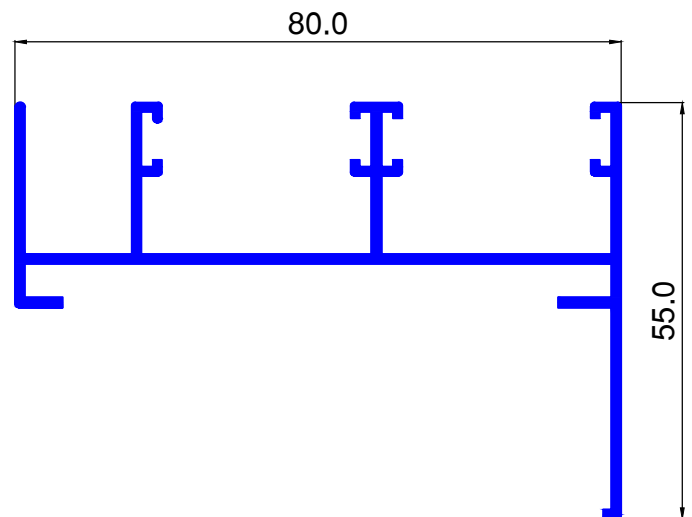

MT272 0.864 kg/ml.

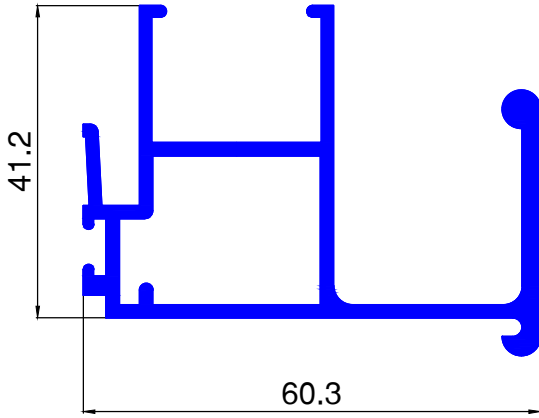

MT201 1.115 kg/ml.

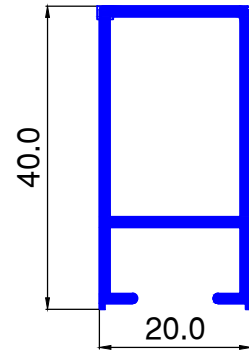

MT273 0.451 kg/ml.

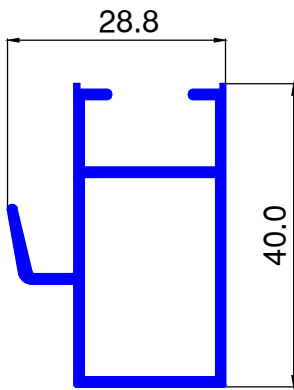

MT227 0.486 kg/ml.

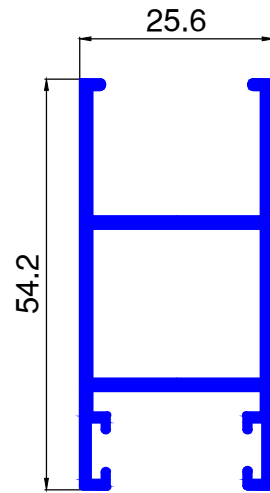

MT202 0.750kg/ml

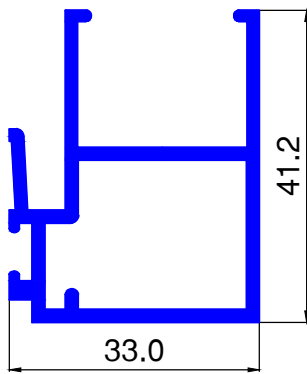

MT203 0.729 kg/ml.

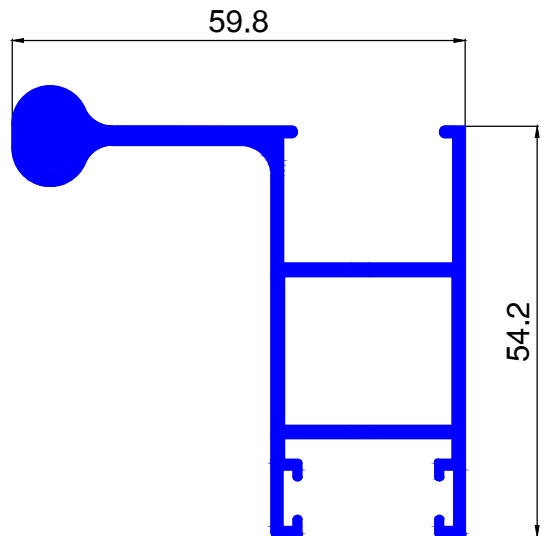

MT205 1.007 kg/ml.