

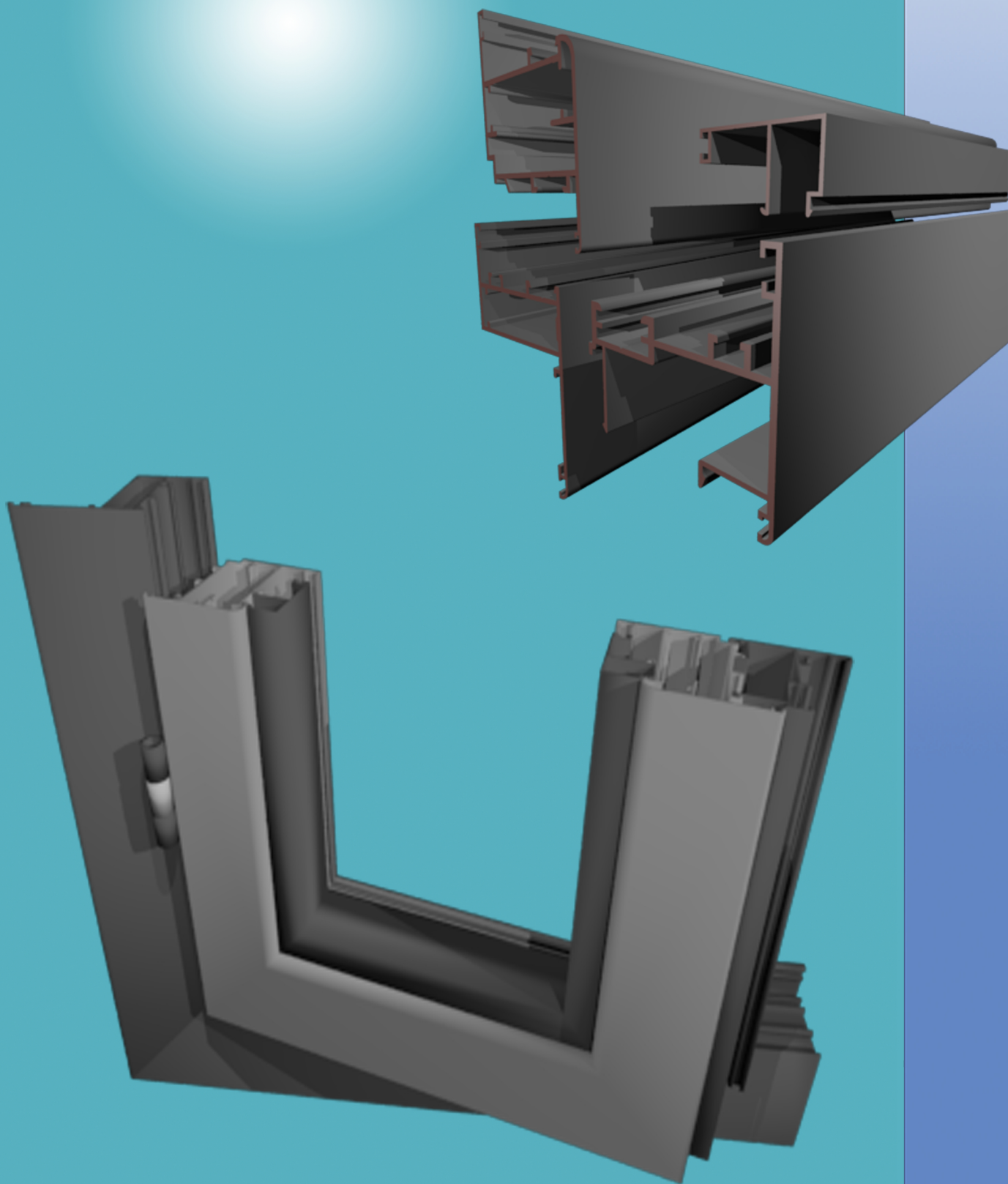

HINGED SYSTEM

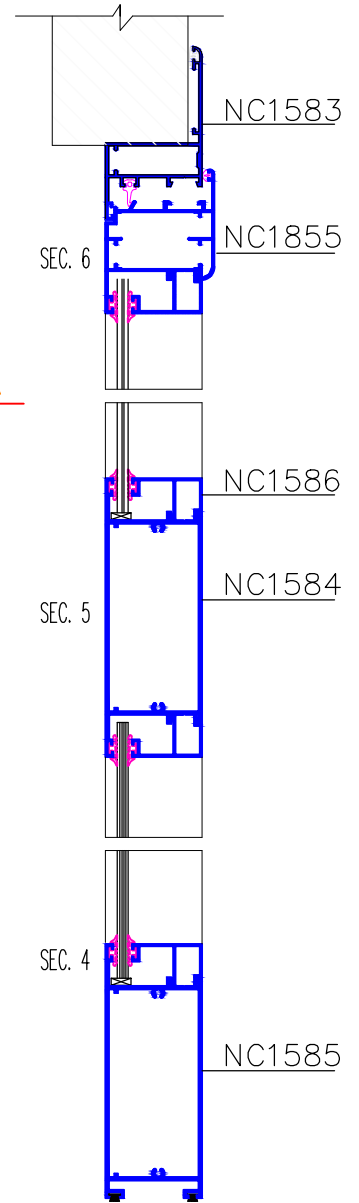

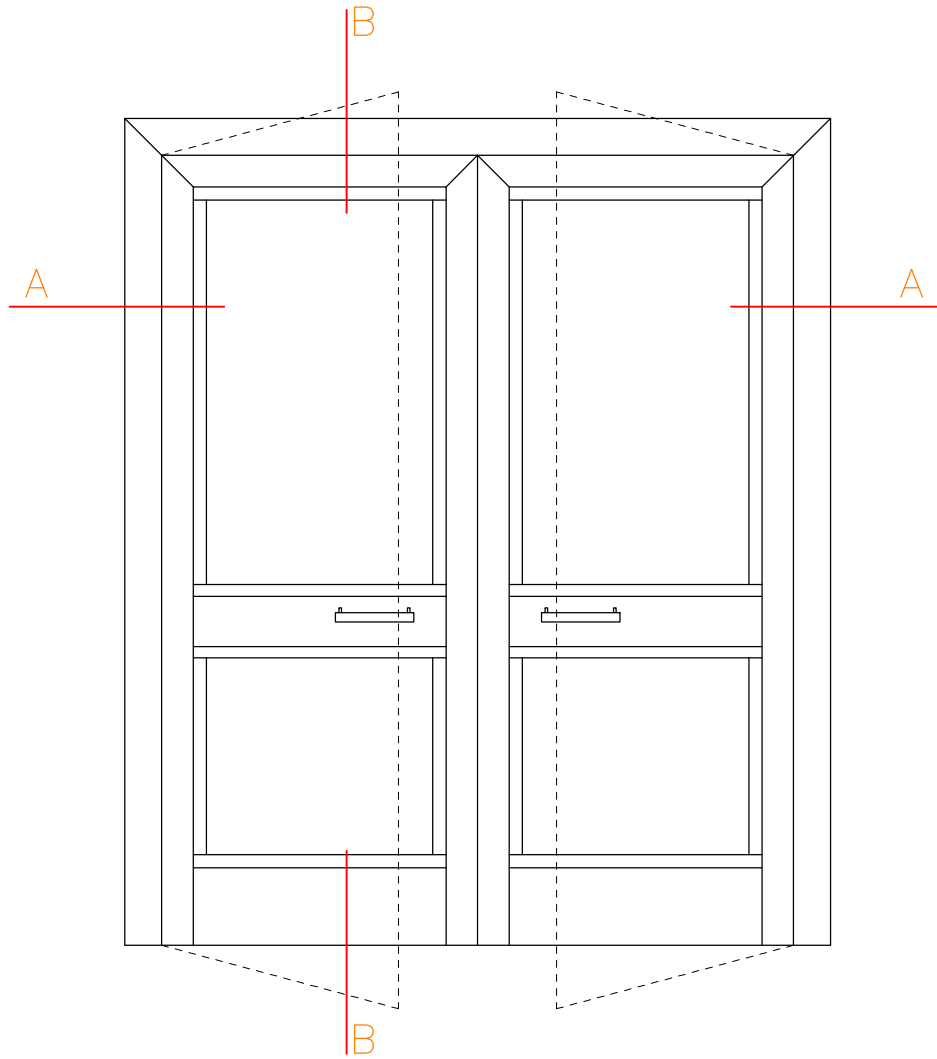
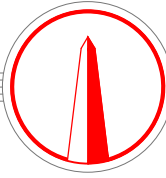

Section B-B

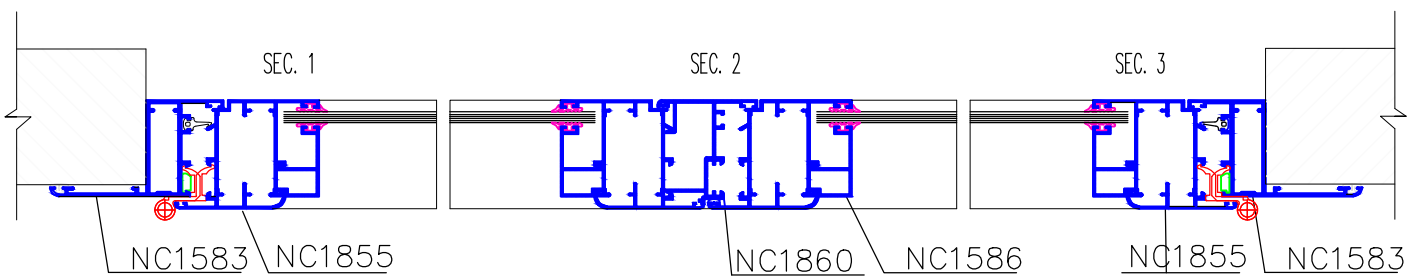

Section A-A

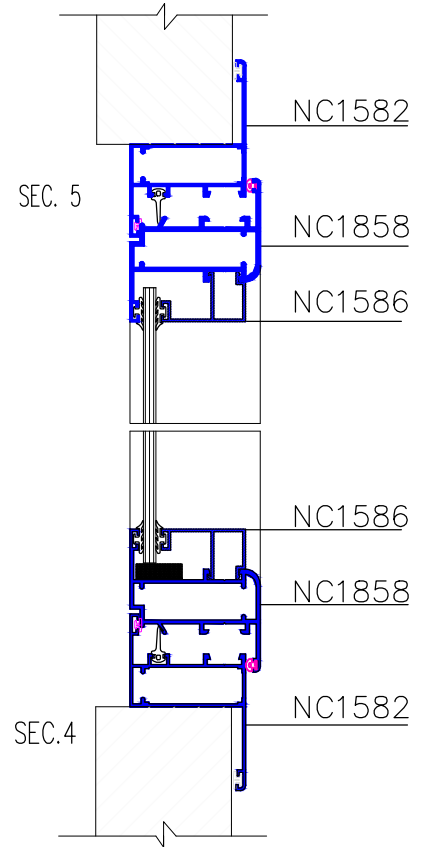
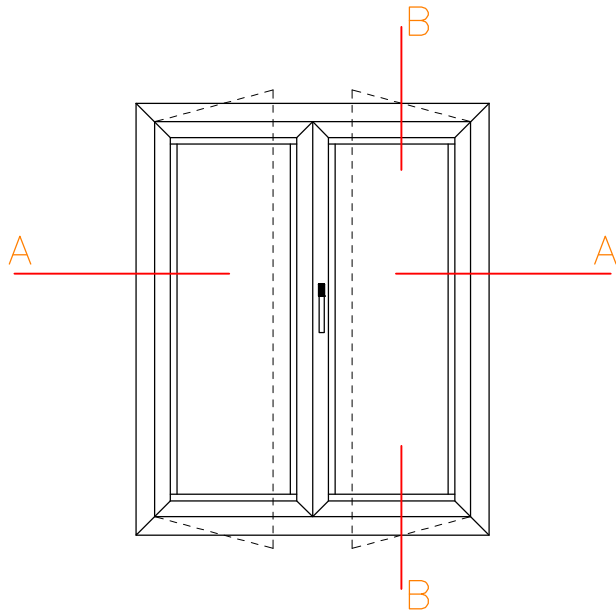
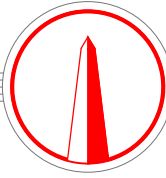

Section B-B

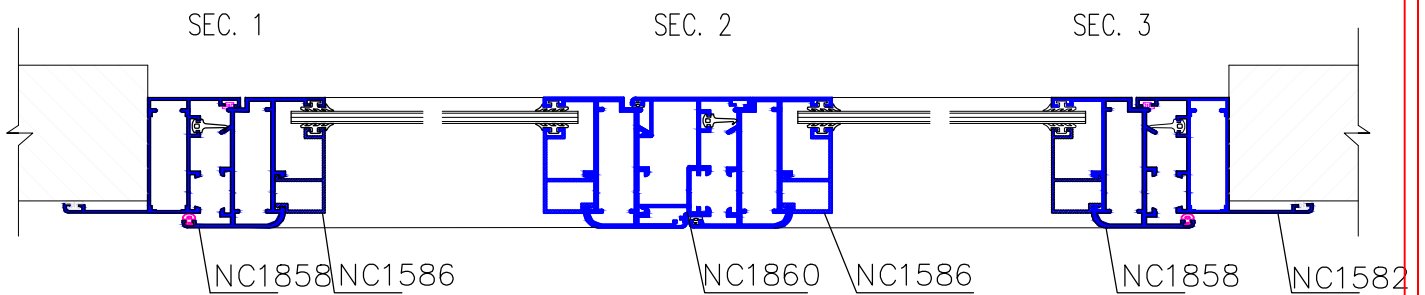

Section A-A

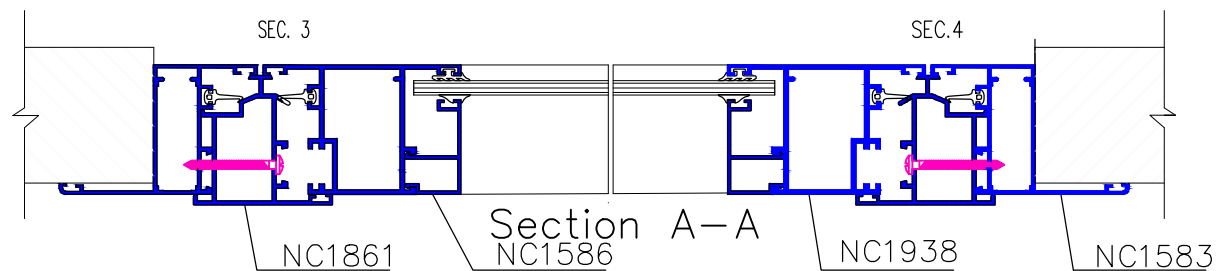
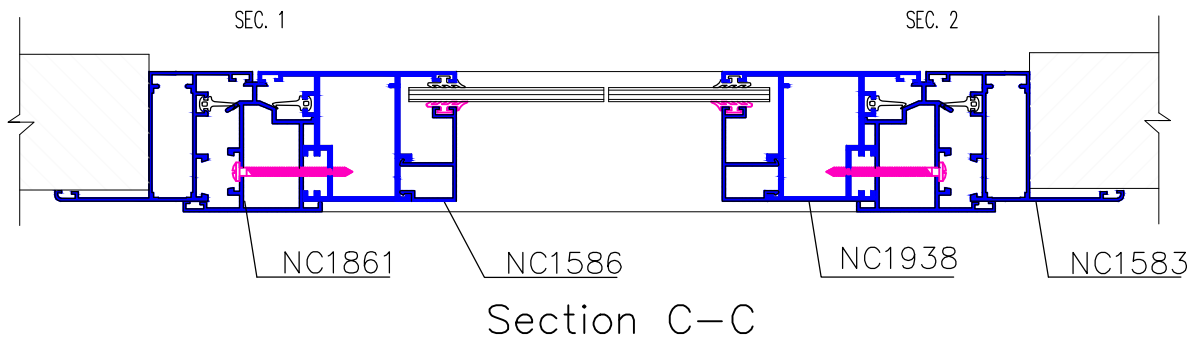
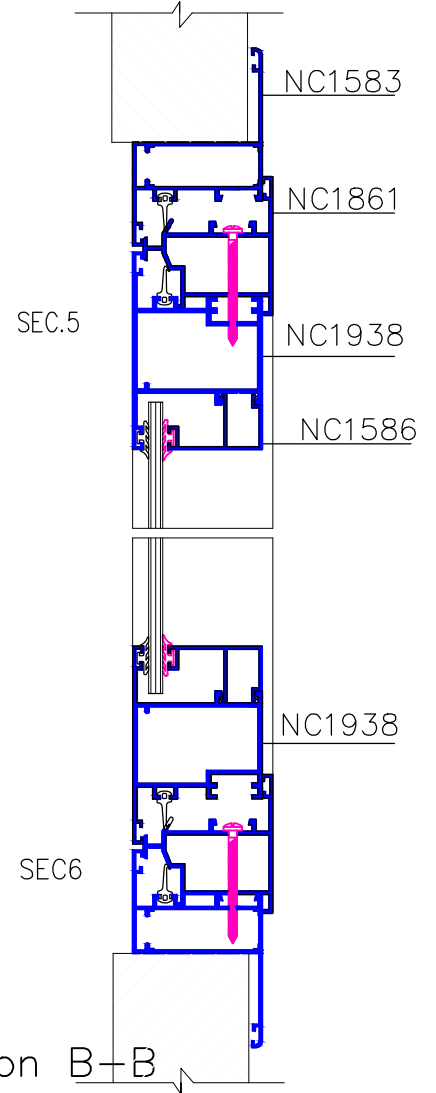
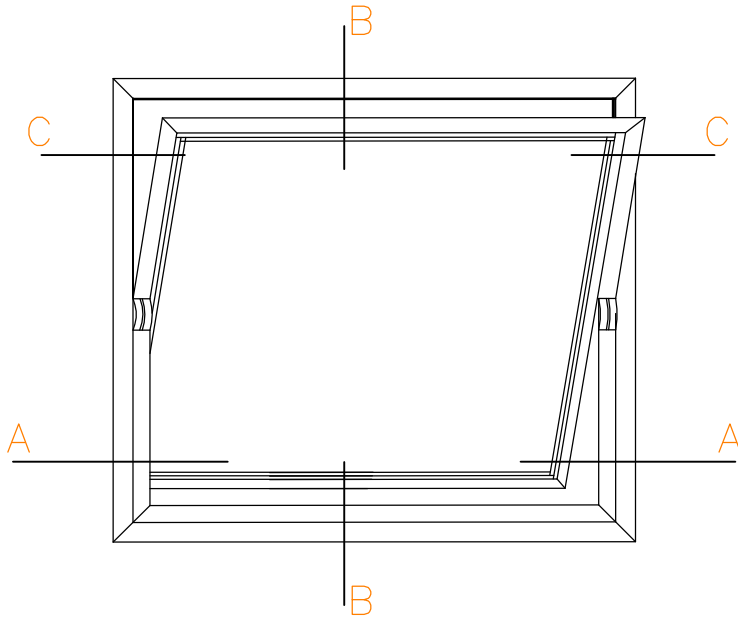
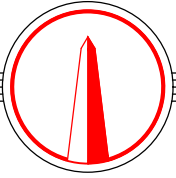

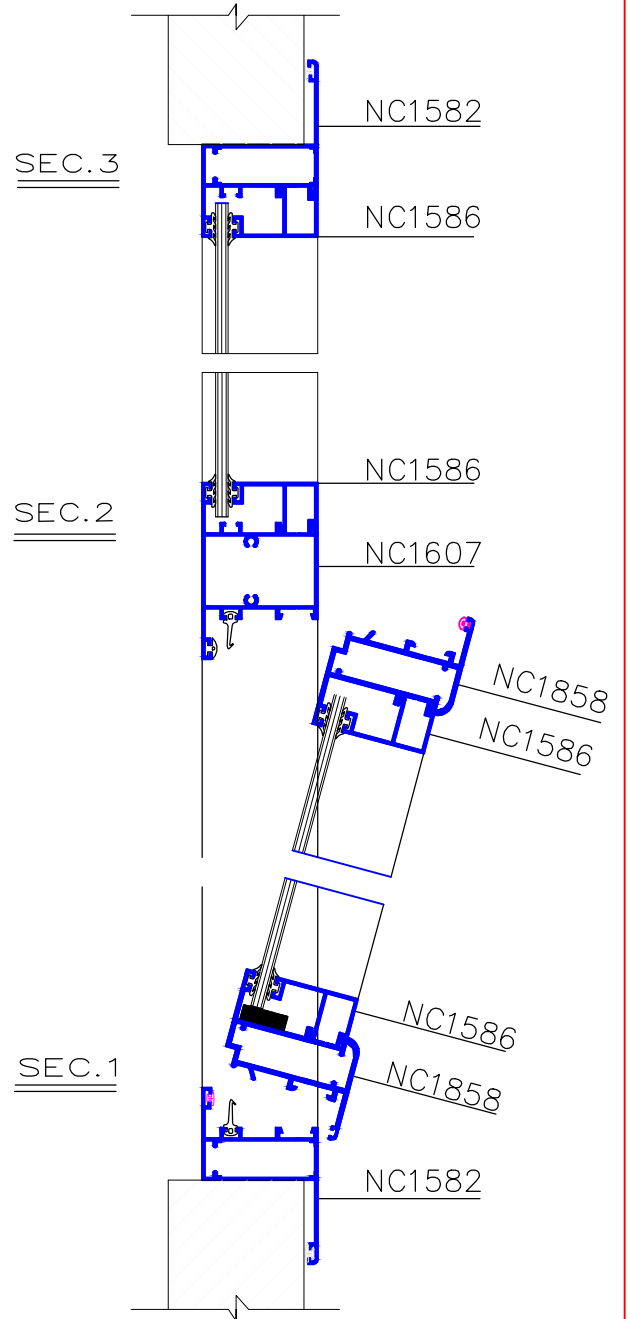
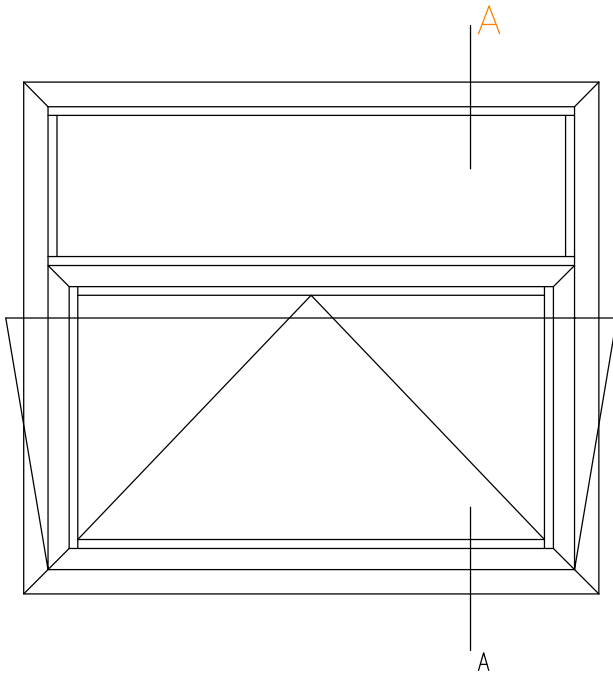
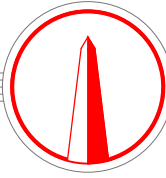

Section A-A

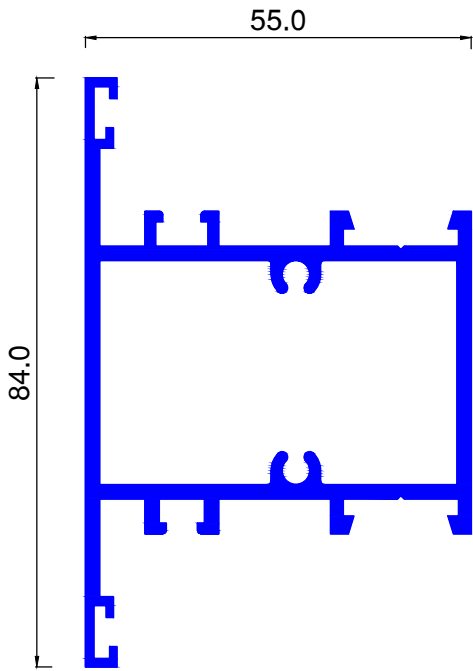
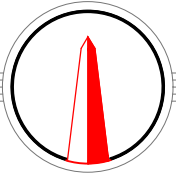

NC 1706 Kg/ml. 1.624

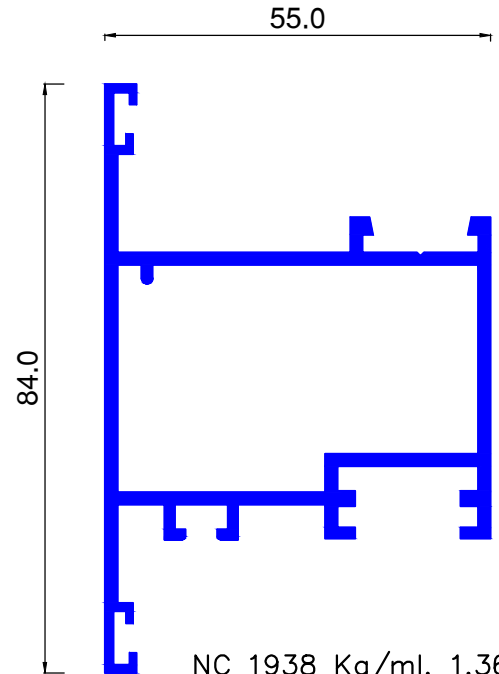

NC 1938 Kg/ml. 1.361

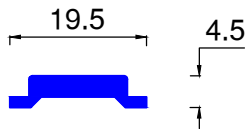

NC 1459 Kg/ml. 0.162

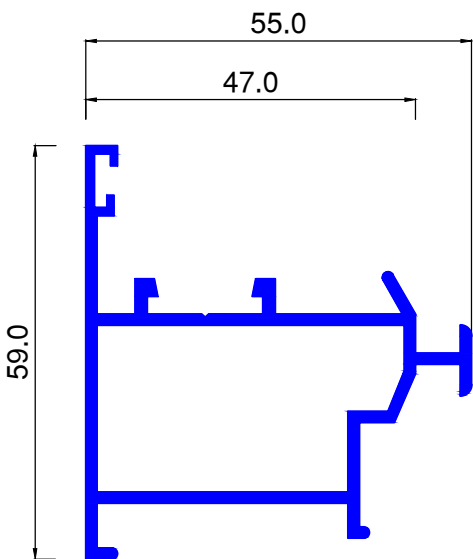

NC 1861 Kg/ml. 0.959

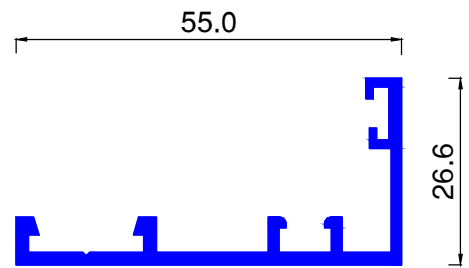

NC 1601 Kg/ml. 0.516

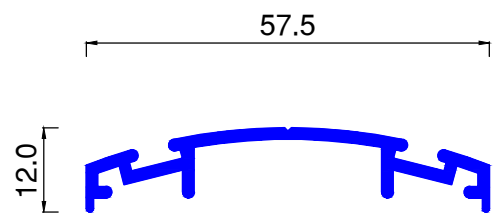

NC 1718 Kg/ml. 0.427

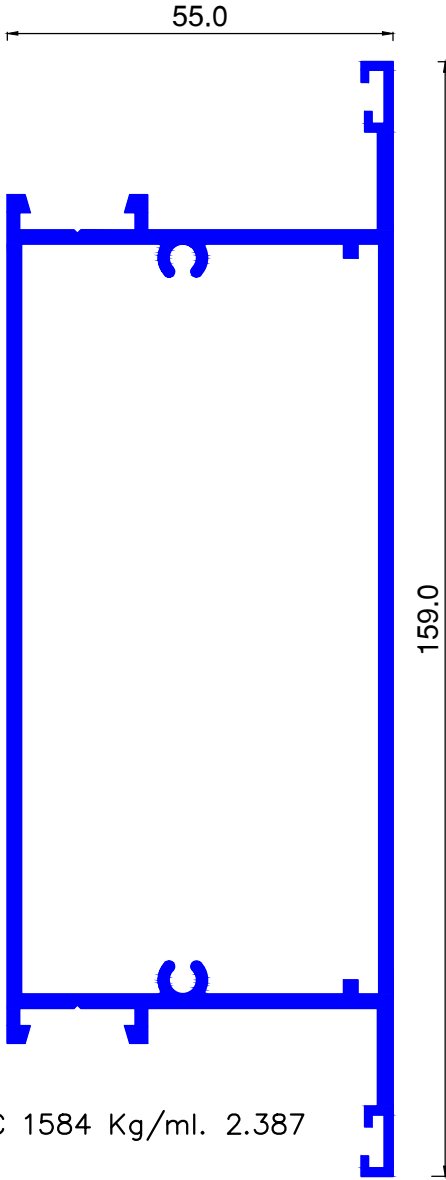
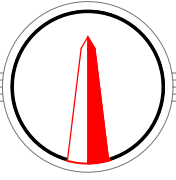

NC 1584 Kg/ml. 2.387

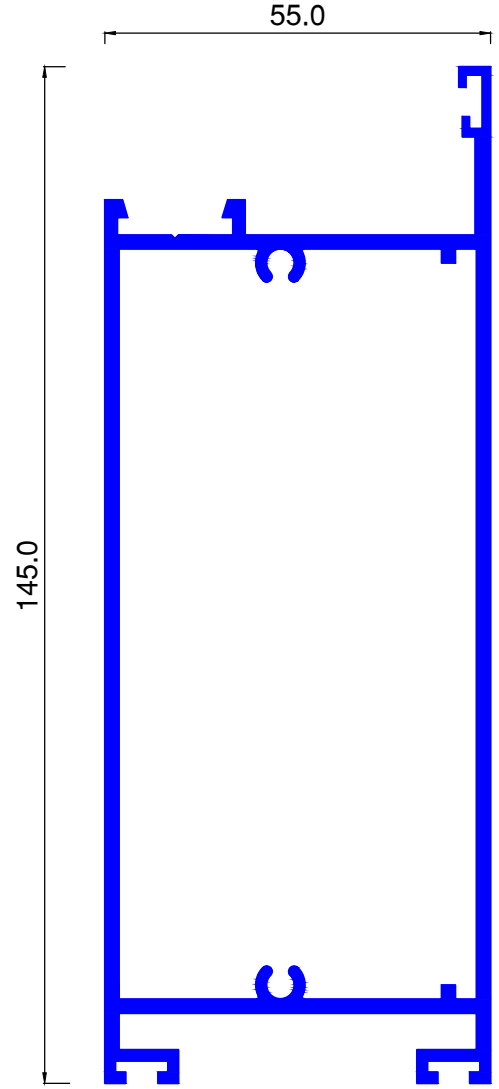

NC 1585 Kg/ml. 2.412

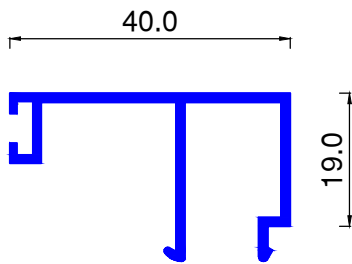

NC 1586 Kg/ml. 0.378

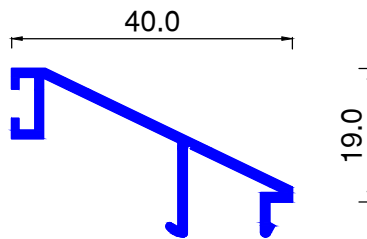

NC 1587 Kg/ml. 0.278

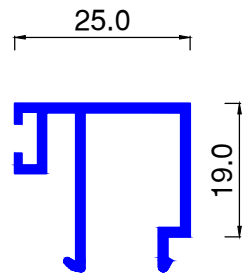

NC 1704 Kg/ml. 0.311

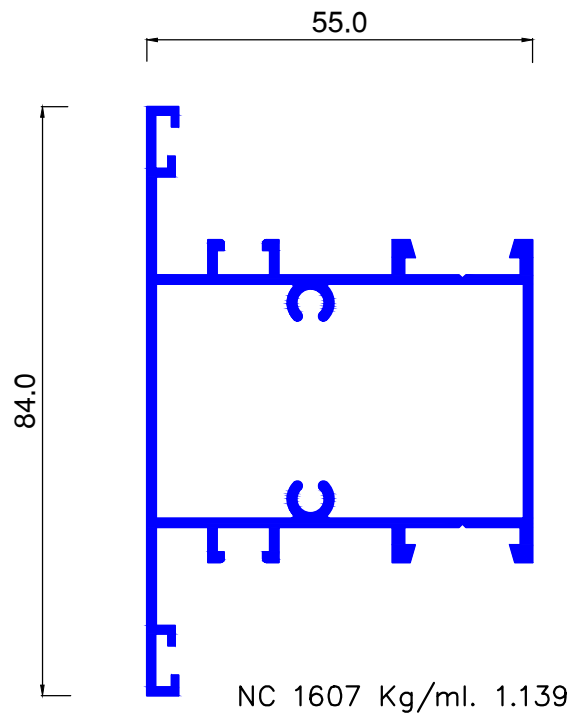
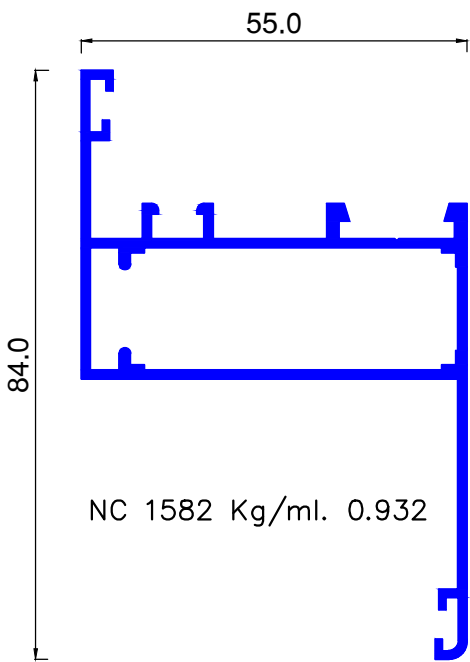
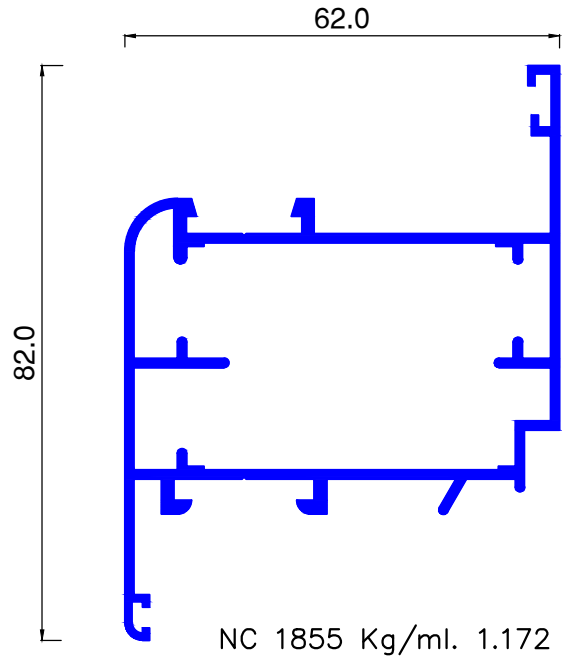
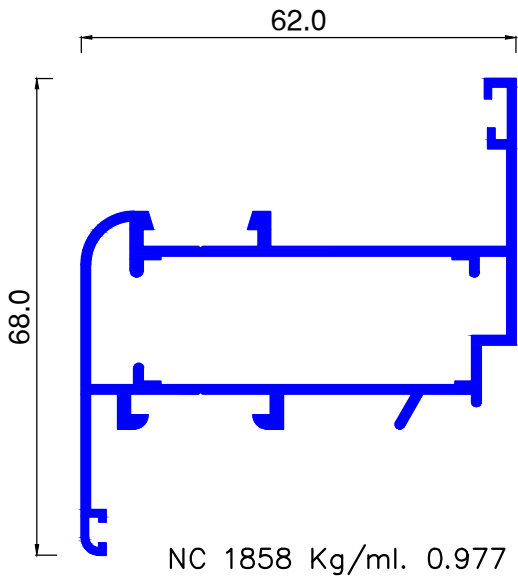
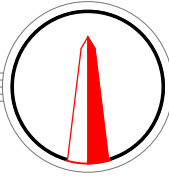



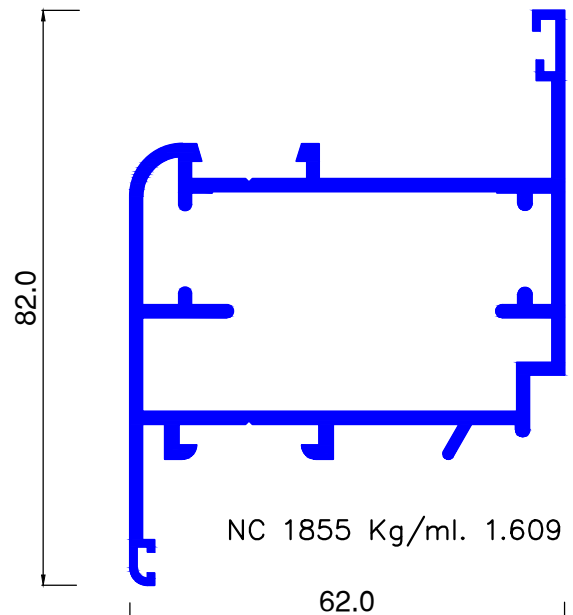
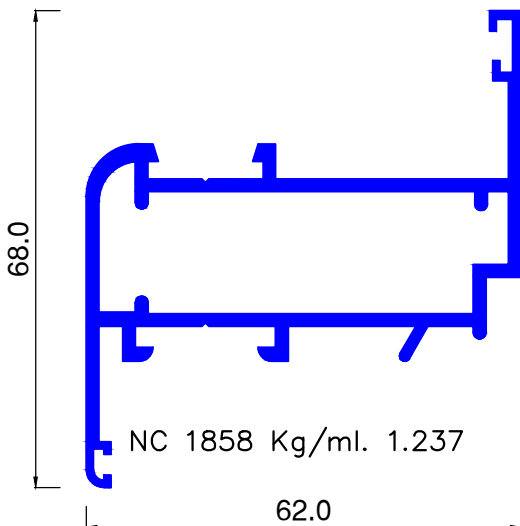
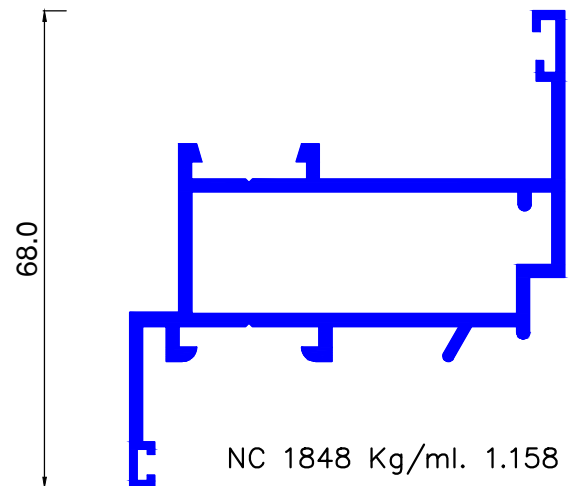
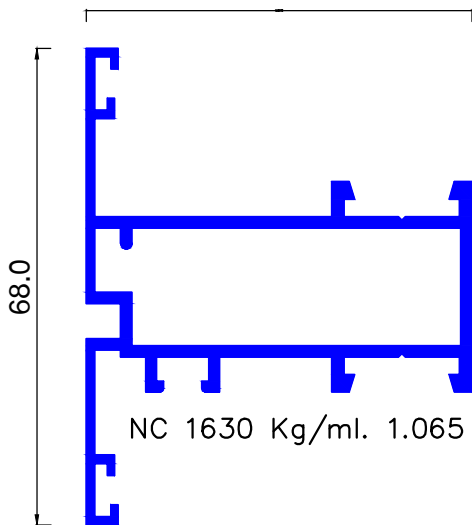
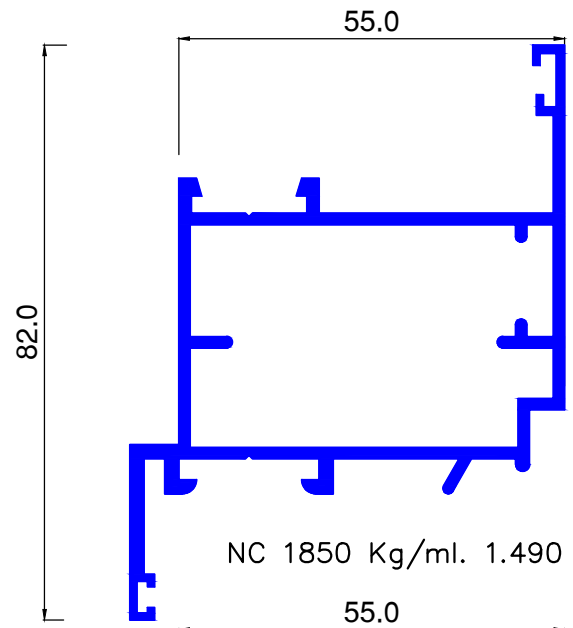
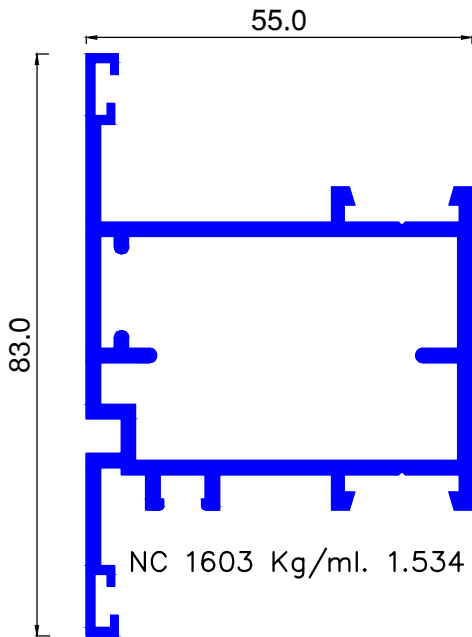
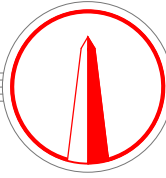

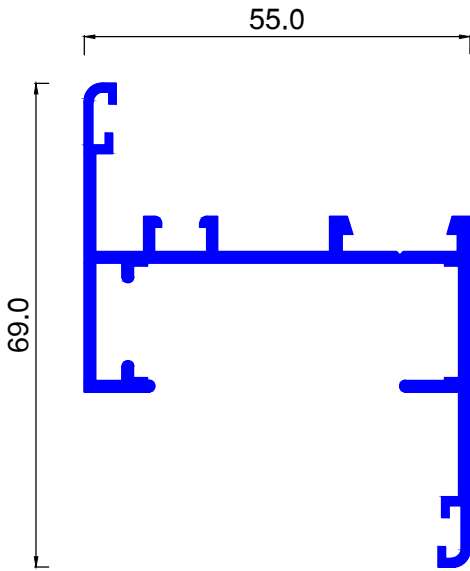
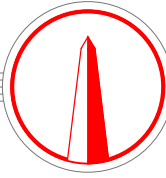

NC 1582 Kg/ml. 0.991

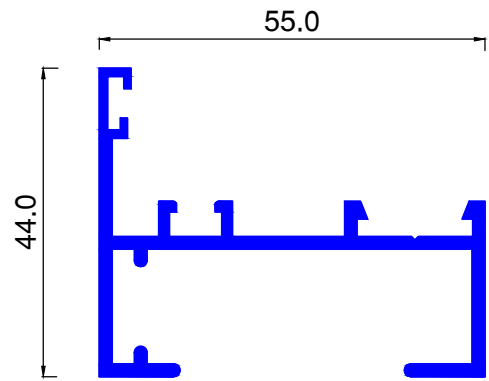

NC 1597 Kg/ml. 0.883

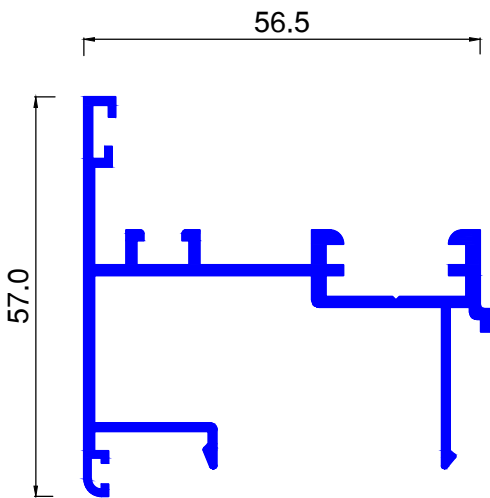

NC 1860 Kg/ml. 0.845

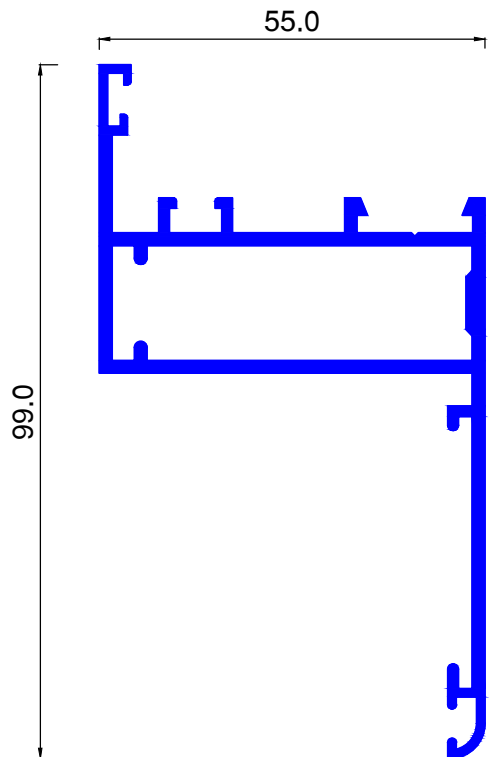

NC 1583 Kg/ml. 1.293

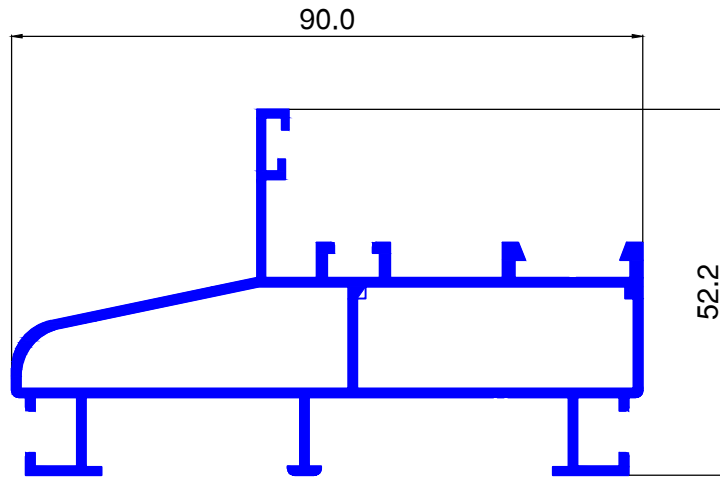
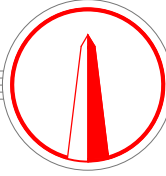

NC 1528 Kg/ml. 1.207

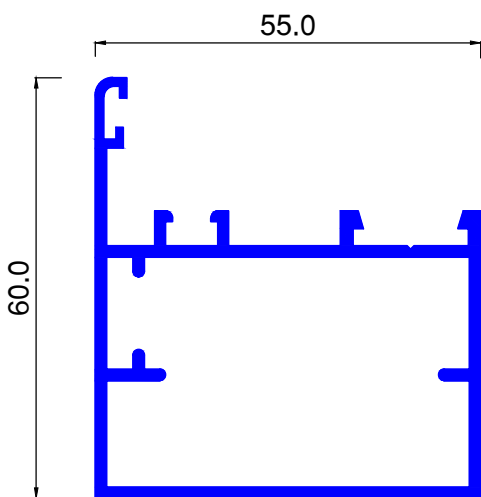

NC 1598 Kg/ml. 1.245

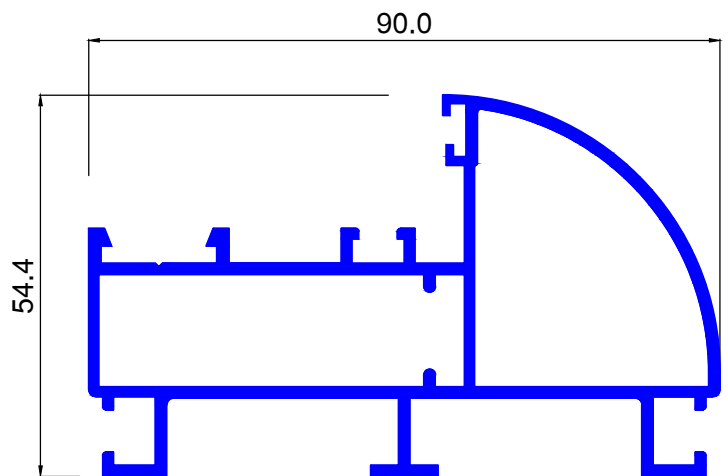

NC 1596 Kg/ml. 1.401